



ENERGY SAVING PRODUCTS

AIR CONDITIONING, HEATING, AND REFRIGERATION



INDEX

5 Gallon Buckets and Accessories	40	Four Way Key	15
6 'N1 Wrench	14	Fuse Puller, Bussmann	51
8732 Silicone	1	Fuses, Bussmann	49-51
8736 Hi-temp Silicone	1	Gas Ball Valves	22
Absorbent Pads	4	Gasket Book, Finny's	33
AC Leaf & Debris Protector	45	Gasket Scraper	13
AC&R Silicone	1	Glycol Refractometer	46
Acid Blaster, 2 Gal	56	Grease Gun, Hose / Plews	12
Acid Pumps	7	Grease, Bearing / General / Food Grade	3
ACR Wingman	16	Grease, Red	4
Air Switch Tubing	83	Hand Cleaners & Towels	38-39
Air Switches, Commercial	80	Heat Blocker, Reusable	48
Air Switches, Residential	81-83	Heat Guns,	48
Anti-Windmill Brake	13	Heresite Touch-up Spray	35
ATC Fuses, Bulk	53	Hex Revolver	16
Big Shot, 3 Gal	56	Hot Water Hoses	60
Board Removal Tool	18	Humidifier Solenoids / UHS	41
Bottles, Industrial Spray	56-59	Humidifier Water Pads	42
Brass Compression Fittings	34	HVAC Service Center	62
Brushes, Schaefer	65-79	Insulation Adhesives	8-9
Bull's-eye Nozzle	60	KITZ Y Strainer	22
Butyl	3	Knit Gloves	36
Calipers	15	Li'L Popper	11
Caulking Guns	12	Light Bulbs	55
Cement, Wet/Dry Roof	6	Line Drive Condensate Blow out	20
Chiller Builder Kits	86-87	Mag Wheel Acetylene Tank Knob	16
CO2 Cartridges	25	Mini Split Fittings	61
Compressor Pad Valves	30	Natural Refrigerant Hoses	64
Contractor Trash Bags	38	Nitrile Gloves	37
Core Gripper	17	N-Take 2	10
Coveralls	36	Nut Driver Tool (Z-Tool)	17
Drain Line Guns	25	Oil Hoses	64
Drill Pump	7	Oil Nozzle Tool	15
Easy Levelers	11	Oil Refractometer	46
ESP High Pressure Control Hose and Assembly Kit	63	PB Blaster	6
Expanding Hose	60	Pin Extractor Tool	17
Fan Blade Pullers	13	Power Extension Cords	55
Fast Stat	47	PPE	36-37
Fire Stop	5	Premium Water Hoses	60
First Aid Kits	44	PVC Cement, Primer, Cleaner	8
Flame Guardian	48	Quick Blast Adapter	20
Flex Connect Rubber Couplings	24	Quick Blast Condensate Blow out	20
Flowmeters	19	Raychem Couplings	21
Foam, Expanding, Fire Stop	5	Replacement Parts for Acid Blaster and Big Shot	56

INDEX

Rhino Tank Carrier	18
Rotolock Adapters	31-32
Rotolock Valves	26-29
Scrubs in a Bucket	39
Shoe Covers	36
Shop Cloths	38
Sight Glass Tool	18
Sight Glasses	30
Smoke Detector Tester	43
Smoke Emitters	43
Solenoid, Water Source Heat Pump	19
Spray Bottles	58-59
Spray Paint	35
Stretch Straps	14
Sure Temp Thermometer	45
Tape, Teflon Thread Seal	9
Teflon O-Ring Kits	33
The Little Black Box	10
The Old "Switcheroo" / Furnace Magnet	10
Thermo Plug	47
Thermostat Covers	61
Tommy Gun Replacement Parts	57
Tommy Gun, 2 QT	57
Tommy II, 48 oz	57
Tool Light Flash Light	54
Transition terminals	54
Tubing Clamps	84
TXV Power Head Wrench	18
Unit Disposal Labels	44
Vent Screens	61
Vibration Absorbers	85
Vulkem 116	2
Wago Connectors	52
Water Ball Valves	23
Water Gate Valves	23
XtraBond 150	2
XtraBond 250	2
Y-Strainer, Bronze	19
Y-Strainer, Plastic	19

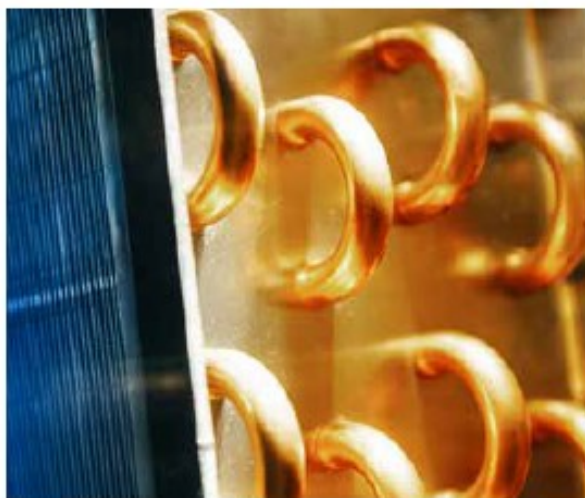



8732 Premium 100% Silicone

8732 Premium 100% silicone has exceptional adhesion and sealing qualities. This product meets USDA, FDA, UL, and NSF and has -40° to +450° F range. For general purpose refrigeration, air conditioning and heating applications. Available in 10.3 oz. cartridges or 3 oz. squeeze tube, individually boxed in clear, white, aluminum, or black.

**8732 C,W, A, B 10.3 oz cartridge or 3 oz squeeze tube
Quantity 6 Per Box**



8736 Hi-Temp Silicone

8736 Hi-temp silicone is also available, with use range of -85° F to 500° F (intermittent to 600° F, red only.)

8736R

10.3 oz cartridge or 3 oz squeeze tube

Quantity 6 Per Box



AC&R Silicone

AC&R New low cost 100% silicone has exceptional adhesion and sealing qualities. This product meets USDA, FDA, and has -40° to +450° F range. For general purpose refrigeration, air conditioning and heating applications. Available in 10.3 oz. cartridges in clear, white, aluminum, or black.

**ACR C,W, A, or B, 10.3 oz.
Quantity 6 Per Box**

XtraBond 150 RTV Silicone



XtraBond®150 a one component, permanently flexible, RTV (Room Temperature Vulcanizing) mildew-resistant silicone sealant that is the industry standard. The product’s tough chemical resistance makes it a worry-free solution for a wide range of applications. Clear.

- Approved for Cultured Marble
- Excellent Adhesion to Glass
- Window & Door Approved
- Easy to Gun, Easy to Tool
- Non-Sag & Slump
- Non-Paintable



XB150
Quantity 24 Per Box

XtraBond 250 RTV Silicone



XtraBond®250 anti-microbial formula is NSF approved and FDA compliant, so it can be used confidently around food applications. Its resistance to moisture makes it ideal for use in high moisture areas such as marine, baths, and walk-in coolers. Available in aluminum, clear, and white

- Consistent Gunability & Tooling
- Approved for Cultured Marble
- Anti-Microbial Formula
- FDA/USDA Compliant
- Excellent Adhesion
- Non-Paintable



XB250
Quantity 24 Per Box

VULKEM 116



Vulkem 116 is a textured, single-component, moisture-curing, gun-grade polyurethane sealant. Vulkem 116 is an excellent general-purpose sealant designed for use on poured and precast concrete, masonry work, window and door perimeters, and similar types of construction joints. Available in Gray, White, and Bronze.

VM116G, 10.3 oz.
VM116W, 10.3 oz.
VM116BZ 10.3 oz.
Quantity 30 Per Box



ESP Butyl Caulk

An inexpensive sealant used as perimeter seal, or capping around windows, doors, masonry or metal to metal applications. Used extensively in refrigerated cases, walk-in cooler doors by the fast food and convenience store market. Available in White and Gray.

7757WC - White 11 oz - Quantity 12 Per Box

7757GC - Gray 11 oz - Quantity 12 Per Box



Mobil Grease Polyrex "EM"

Super-premium Mobil Polyrex EM Series grease is specially formulated for electric motor bearings. The advanced thickener formulation and proprietary manufacturing techniques provide improved bearing performance and protection for long electric motor life.

EM - Blue 14.1 oz - Quantity 10 Per Box



Mobil Grease "EP"

Mobil Premium Lubricating Grease is a lithium thickened grease containing oxidation and corrosion inhibitors. It is suitable for lubrication of high speed ball and roller bearings found in motors, saws, spindles, generators, fans, and squirrel cages. Superior water resistance. Meets GM spec 7830695, 998537, and Detroit Diesel Corp. 1Y12 spec. - 30° to 350° max exposure. Available in 14.1 oz. tubes.

EP2 - 14.1 oz - Quantity 10 Per Box



Mobil Grease XHP222 / FM222

Mobil Extended High Temp Service is a suitable bearing grease providing water resistance and corrosion protection for industrial, construction and marine service. Available in 14.1 oz. tubes.

XHP222 - 14.1 oz - Quantity 10 Per Box

FM222 - 14.1 oz - Quantity 10 Per Box

GREASE

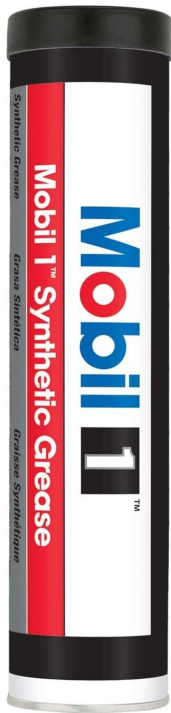

Mobil Red Lithium Grease

This is an advanced full synthetic grease formulated with a proprietary blend of high-performance synthetic base stocks and a lithium complex soap thickener. The thickener system provides a high dropping point, while additives impart excellent extreme-pressure properties and resistance to water wash, rust and corrosion. The proprietary blend of high-performance synthetic base stocks used in Mobil 1 Synthetic Grease gives reliable lubrication over wide temperature ranges -50 C (-58 F) to 246 C (475 F).

121071 - 14.1 oz - Quantity 10 Per Case

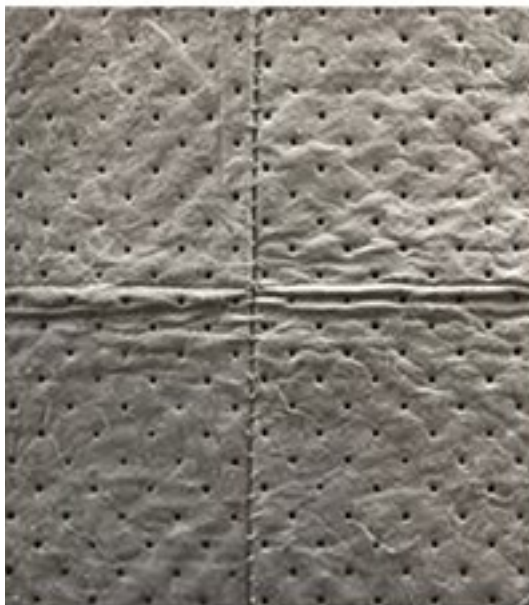

Absorbent Pads

Perfect for oil spills or placing under vacuum pumps when changing oil. These pads and rolls are constructed of two layers of fine fiber polypropylene and are ultrasonically bonded around a high-loft meltblown core. 15" x 17"

ABSP25 - Pack of 25 pads



FireStop Foam

Great for residential applications. Foam is better than conventional fire-block products at blocking smoke & flames, and has proven cost effectiveness due to easy application & excellent yield rate as opposed to standard caulks and fiberglass. Orange in color.

P30033 12 OZ. (12/cs)



Expanding Foam

This foam is a low-pressure, one-component, polyurethane foam sealant is a moisture-cured, multipurpose sealant designed to seal and fill small cracks and voids, creating a tight barrier against noise, moisture and air infiltration. HandiFoam® Sealant is UL GREENGUARD Gold Certified, contributing to healthier indoor environments.

P30002 - 12 OZ. (12/cs)

P30181 - 24 OZ. (12/cs)



FireStop

This is a latex based, high solids firestop caulk. This material, when properly installed, effectively seals penetration openings in wood frame construction against the spread of fire, smoke and combustion byproducts. It is a single stage intumescent. When exposed to elevated temperatures, WF310 expands rapidly to seal off voids left by the burning or melting of combustible materials.

WF310 - 10.1 OZ. (24/cs)



PB B'laster

B'laster PB Penetrating Catalyst is a powerful, concentrated penetrant that frees stubborn rusted or immobilized parts by releasing the surface tension that causes them to stick. PB magnetically creeps up, around and into tight, hard-to-reach cavities, then converts into a high lubricant, loosening troublesome nuts, bolts, rusted joints, pipe threads and other frozen parts in record time! B'laster PB's non-evaporating formula then stays on the surface of the part to protect against rust and corrosion. 16 oz. aerosol.

16-PB-DS - Quantity 12 Per Box



Wet/Dry Roof Cement

A heavy consistency mastic formulated with refined asphalt, filler, plastosizer, and solvent. All-purpose repair cement adheres to damp substrates. Remains soft and pliable through wide temperature fluctuations. Meets all requirements of ASTM D-4586-8-6, asbestos free.

WDRC 1 Gal - 6 / box

WDRC 10.3 oz. - 12 / box



Acid Pump

The ESP compact submersible pump is designed to circulate strong acids and cleaning solutions. All parts are constructed of acid-resistant materials. Motor is protected by thermal overload. Powerful 300 GPH pump.

G325A



NEW Replacement Pump

Drill pump for Glycol/Oil/Any Fluid.

PUP62 and PUP63

PVC GLUE | PRIMER

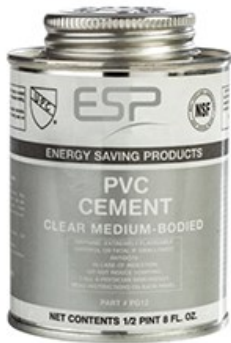

PVC Clear Glue

This medium body solvent cement is used to join PVC pipe and fittings for potable water and drain, waste and vent systems. Recommended for PVC Types I and II, schedule 40" to 8" and schedule 80" to 6" diameters. ASTM D-2564. Available in 1/4 and 1/2 and 1 pint cans with dauber.

PG14 - 24 / box, PG100 - 12 / box



ABS, PVC, CPVC All Purpose Glue

This clear regular bodied cement can be used on ABS, PVC schedule 40 and 80 Type I and Type II, gas pipe, conduit and CPVC schedule 40 up to 4" in diameter. Set time 45 seconds. Available in 1/4, 1/2, and 1 pint containers.

AP14 & AP12 - 12 / box



Purple Primer

Softens and prepares PVC pipe and fittings for gluing . Use for potable water and drain, waste and vent systems. ASTM F656.

PP14 (1/4 pint), PP12 (1/2 pint) 24 / box

PP100 (1 pint) containers, all with dauber - 12 / box



Clear Cleaner

Cleans and prepares PVC, CPVC and ABS fittings for gluing.

PC14 (1/4 pint). PC12 (1/2 pint) - 24 / box

PC100 (1 pint) - 12 / box



Insulation Adhesive

Used by contractors nationwide as the premier insulation adhesive. Is now specified by a major insulation tubing manufacturer to be used on their products. Color: Amber. Viscosity: 200 - 300 CPS. Odor: solvent when wet / none dry. Bonding range: to 20 minutes. CAUTION: Extremely flammable. Avoid open flame or spark. Apply in well ventilated area.

CC12 (1/2 pint) - 24 / box CC100 (1 pint) - 12 / box



ESP Teflon Thread Seal Tape

Teflon thread seal tape offered in both .0035 and .0032 thick tape manufactured by Dupont. Both meet MILT-27730A specs, are recognized by NSF and are approved by NASA. .0035 Tape is UL approved. Available in 260" and 520"

**TT260 or TT520 for 1/2", .0032 mil and .70 density- Packed 100 /box or 10 /sleeve
TTUL260 or TTUL520 for 1/2", .0035 mil, .90 density Both packed 144 /box**

TOOLS

The Little Black Box

DETAILS

- Converts 120V to 24V check systems
- Designed for the lab, available to the contractor
- Perfect for parts counter control checking
- Professional 40" silicone test leads with point probes, and interchangeable alligator clip extensions
- 24v manual reset overload protection
- Lighted 120v power switch
- High strength magnetic backing grips metal surfaces
- One Year Warranty



VP24

The Old Switcheroo

The Old Switcheroo is a heavy duty industrial magnet designed to hold down pop out switches while the technician trouble shoots the furnace or air handler. Two wings will reach out to switches that are set apart from a flat metal surface. A must in the tool box. Ask for free counter display with tri-folds.



FF75

FF75 Display



N-Take 2

This unique device is installed within the draft induction supply line in between the outdoor intake and the furnace. When a blocked intake would normally result in a no heat call, and a shut down furnace, the N-Take 2 opens due to a slight vacuum inside the pipe. Not to be used as a primary combustion inlet. Alternate only.

Free display pictured here.

NT02

NT02 Display





LI'L POPPER Voltage 24V

Li' L Popper control circuit breaker saves the technician dozens of blown fuses while he diagnoses control circuit failures. Simply plug the leads in to the ATC fuse receptacle on the board, and manually reset the Li' L Popper each time the breaker blows. Has a quick setting thermal cut out. Self adhering backing allows the contractor to leave the unit on the job site overnight if he is out of fuses. Available in 3 amp, 5 amp, 10 amp, 15 amp, and 20 amp. Alligator clip versions are available.



POP3, POP5 for residential or commercial amp applications or POP10, POP15, POP20 for microwave and appliance applications POP3Z, POP5Z for Alligator clip versions

Easy Levelers



Revolutionary furnace leveling system created for the perfectionist. Four sturdy bolt-adjusted leg extensions supplied with mounting materials. Simply turn the leg bolted insert clockwise or counter clockwise to raise or lower each corner of the furnace. Supports up to 400 lbs Adjustment from 2 3/4" - 4" Height.

Free display, holds eight packages.

Patent #7,137,604

EL10

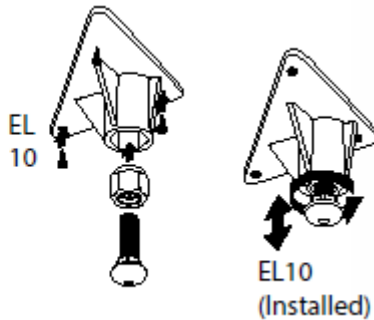
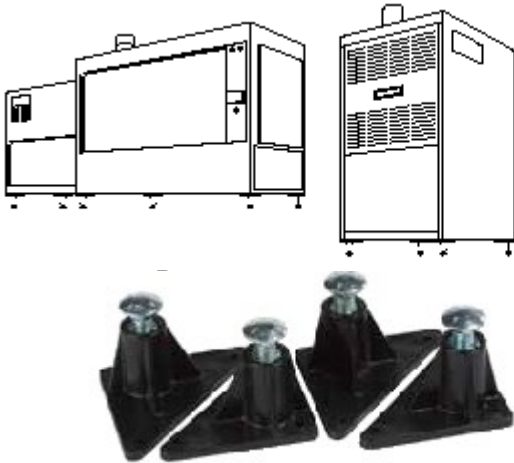

EL10 Display



Caulking Guns



Durable, high quality, and heavy duty. Made of heavy gauge metal with positive action plunger rod.

012-DC

Plews Grease Guns



Meet the toughest grease guns around. The all new grease gun line from Plews. These guns have been completely redesigned and incorporate advanced features that are unmatched in the industry.

Constructed of heavy duty steel and finished in rugged baked enamel and tough zinc plate. Every feature of these grease guns has been engineered for the rigors of professional use. Lifetime warranty.

30200

Grease Hose



There are 1/8" NPT male fittings on each end. Meets U.S. Government mil-spec.

10-212 for 12" and 10-219 for 18"



Fan Blade and Blower Wheel Tools

Fan blade and blower puller tool by ESP offers a simple and easy solution to locked fan blades and blower wheels. Will not damage blower or blade, so the unit quickly pays for itself.

FB100



Wilde Gasket Scraper

Heavy-duty 11" industrial gasket scraper for quick and easy removal with a one inch face and 1 1/2" face.

GS-516 1" Face

GS-516 Wide 1 1/2" Face

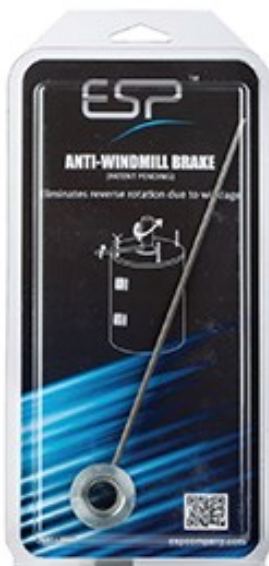

Anti-Windmill

This patented device slips over the motor shaft and will prevent the motor from rotating in the opposite direction due to windage. Most motors will start and continue to run in the opposite direction if the reverse rotation is severe enough, causing premature motor failure. Fits shaft sizes 1/2" and 5/8".

AW12 or AW58

- Wrong rotation will cause the rod to strike thru-bolt, which will stop the shaft from turning
- Shaft will rotate the correct direction freely
- NOTE: This device will stop windmilling in the wrong rotation only

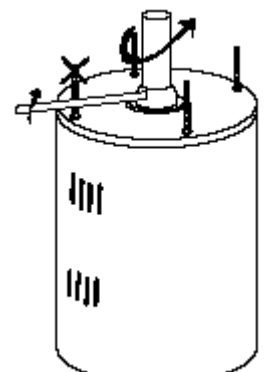



6 'N 1 Lug Wrench

- Offers both hexagon and square sockets
- Four nut drives sized 1/4", 5/16", 11/32", 3/8"
- Two squares sized 3/16" and 1/4"
- Use as a handle for 1/4" extension drives
- Fits MC and B acetylene tanks
- Fits service valves
- High-quality vanadium tool steel
- Easy grip round handle
- Pocket sized
- Lightweight and compact
- All drives will accept long screws
- Individually bagged with card & hanging tab

LW601



Rubber Stretch Straps

The specially compounded rubber resists sun and weather to last indefinitely. Tensile strength to 50 pounds. Made In the USA Available in 10", 15", 21", 31" and 41"

RS10, RS15, RS21, RS31 or RS41



Nozzle Buddy

The easiest way to change oil nozzles

40437



Pocket Caliper

Stainless steel 3" caliper, 1/32" and millimeters, inside, outside graduations.

132ME



Utility Vernier Caliper

0-5" range, mm and 16th graduations. Durable Steel Construction

722

For 0-4" Stainless order 729

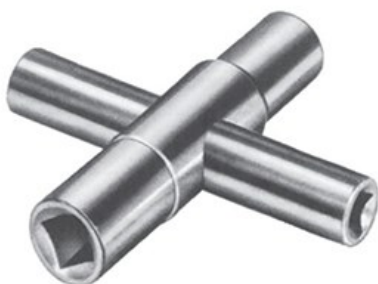

Four Way Key

Fits stopcocks, sillcocks, and valves. Sizes are 1/4" to 9/32" and 5/16" to 11/32" Precision machined plated steel.

FW1701

TOOLS

NEW



New From ESP—The Mag Wheel

Perfect for opening acetylene tanks that don't already have knobs, this ultra magnetic tool allows you to easily open and close tanks without a wrench. Never lose it with an ultra rare earth magnet.

MW10

New From ESP—ACR WINGMAN

NEW

Condenser fan motor out? Provides temporary coil cooling with water fan spray until motor replacement complete. Heavy duty magnetic attachment to attach to condenser enclosure. Shut off valve in handle

WM1



NEW



The Hex Revolver

Featuring 6 color-coded screwdriver holder for easy sorting and quick identification of bits and chucks. Keeps frequently used driver bits within reach. Quick-release design for effortless bit changes.

ESP's newest product, the Hex Revolver, is a must have for any technician. The kit includes a top of the line keychain, with six hex bit holders, and six impact rated, magnetic hex bits - 1/4", 5/16", 3/8", 7/16", 1/2", and 9/16". On your belt or on your bag - keep them handy at a great price.



BH1



Z-Tool

This handy dual nut driver has 1/4" and 5/16" pivoting sockets to reach the most difficult angles and tightest screw locations.

ZT10

ZT10-Bulk 25/Box

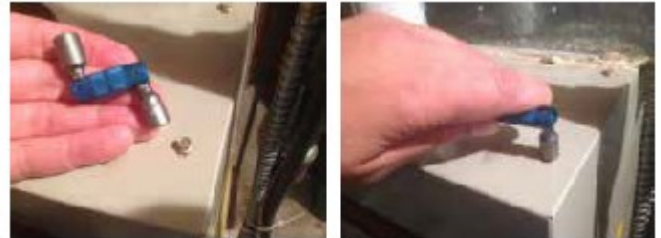

Pin Extractor Tool

This handy tool will help to pop out Molex and Amp Electrical pins in igniter and other controls.

PE44



Core Gripper

Just push in the base to extend four gripper fingers and the spring release grabs the core so that it can be turned out and removed.

CGR10



TOOLS



Sight Glass Tool

The ESP sight glass tool slides easily into the notches of a scroll compressor sight glass and easily helps to extract the sight glass with a crescent or socket wrench. 1" diameter.

SGRT

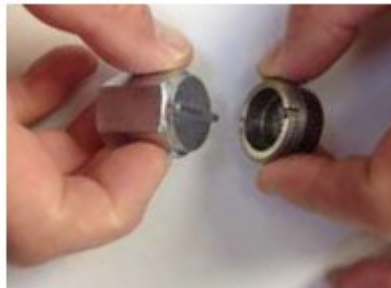

Board Removal Tool

Remove boards from their standoffs easily. Dual sided tool easily compresses both sizes of standoffs seen in the HVAC/R industry. A must have for the truck.

BRT10



TXV Power Head Element Wrench

This handy wrench fits most Sporlan and Alco power head elements for easy removal and replacement.

PH10



Rhino Tank and Compressor Tote

The Rhino tank and compressor tote allows the user to easily pick up nitrogen, CO2, and oxygen 20 and 40 lb cylinders, along with all hermetic compressors with lift tabs

RH10



ESP Flowmeters



Ground water-sourced, heat pump applications. This high quality polycarbonate bodied flowmeter has 3/4" MPT nylon threaded connections and 1-10 GPM capacity.

LDF357N- 3/4" MPT 2-10 GPM

LDF359N-3/4" MPT 2-18

C-1K55-A020 King Glass/Brass Liebert Replacement 1" MPT



Pro-Line 1" NPT-Solenoid Valve

Normally closed 24V or 115V slow closing 150 psi solenoid valve for use on ground water source heat pumps. Maximum operating temperature 110°F.

HP215 or HP510-115

ESP BronzeY-Strainers



Used primarily for all water applications. Working pressure: 300psi W.O.G.; 150psi W.S.P. 80 Mesh screen, 1/2" thru 3/4" sizes.

BY12 (1/2") - 8 per box

BY34 (3/4") - 8 per box

ESP Plastic Y-Strainers



Used extensively in the ice machine and water cooler industries. Size 3/8" Manitowoc part# 136067-9; Scotsman part # 16-0162-00.

PY38

VALVES AND COUPLINGS



QuickBlast

The QuickBlast is the easiest way to service condensate lines. Once installed, simply turn the ball valve closed, supply pressure upstream, then downstream, and turn the ball valve back open. No additional tools, no leaks, no restricted flow - just a quick and easy way to clear lines.

QBI



Quick Blast Adapter

Connect a drain line gun directly to a Quick Blast or Line Drive.

QBA



Line Drive

This 3/4" x 3/4" slip on condensate pan blow out valve is a patented one of a kind item. No more buying little cartridges and trying to find the end of drain lines in the dark. Simply install this unit exiting the evaporator in your residential or commercial AC system, and hook up a 1/4" charging hose to the valve and the other end to your CO2 or Nitrogen tank. Turn the valve one way, and blow out the line. Turn it the other way, and remove any blockage inside the coil.

LD10 (8 per box)



Raychem Aluminum to Copper Refrigerant Coupling



Raychem tube couplings, repair leaks in aluminum or copper/aluminum joints.. When heated with a propane torch, this one-piece coupling shrinks to join and seal refrigerant tubing. Unlike traditional joining methods such as welding and brazing, where joint quality depends on preparation and technique, Raychem couplings create strong, reliable joints time after time. Joining copper or aluminum in hard-to-reach places. Trouble-free reliability. One-piece construction eliminates the problem of parts that vibrate loose after assembly. And Raychem tube couplings are stronger than the tubes they connect. They withstand pressures up to the burst pressure of the tubing, pullout forces in excess of the typical yield strength of the tubing, and vibration fatigue up to the failure of the tubing.

Easy to install. The only tool required is a propane torch. No flux, no solder, no wrenches are needed. Merely slip the coupling over the tube ends, and heat. A colored band at either end changes color to signal when the installation is complete. (This takes approximately 20 seconds for a 3/8" coupling.) And, because there is no residue, there is no need to flush the tubing. Now it is fast and easy to make these permanent, reliable joints even in hard-to-reach places.



PCL 1/4, PCL 3/8, PCL 1/2, and PCL 5/8 - 10 / box

PCL RAYCHEM DISPLAY, N/C.- 10 / box

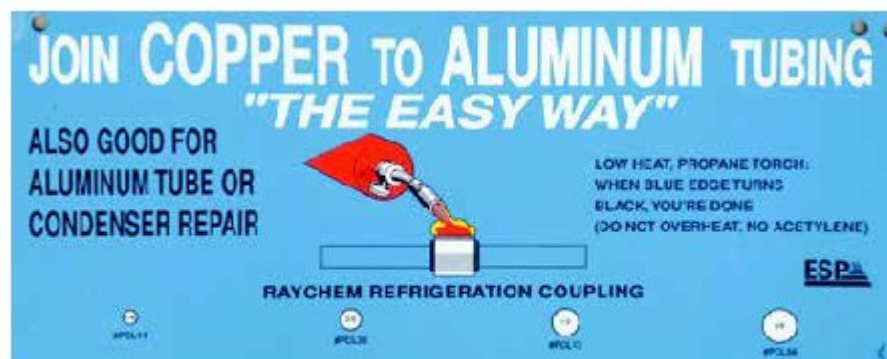
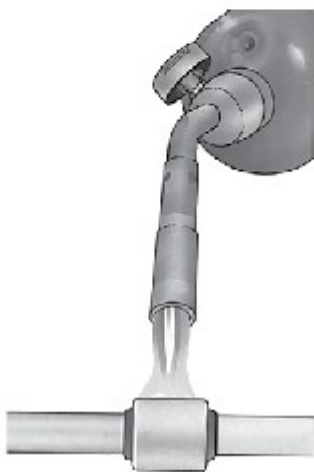

"FREE DISPLAY"

KITZ

Code No.15 (Fig. AKYU)



Class 150 Y-Pattern Strainer

Y-Pattern Strainers provide protection for equipment having internal moving parts. Has blow-out outlet for easy clean-out, threaded cap for easy removal. Bronze body and Type 304 stainless steel screen. NPT threaded ends or solder joint ends.

Working Pressure
300 psi. W.O.G. non-shock
150 psi. W.S.P. saturated

Test Pressure
Shell450 psi. hydrostatic

Dimensions	inch					
Size	1/4	3/8	1/2	3/4	1	1-1/4
L (IPS)	2.76	2.76	3.15	3.94	4.53	5.31
L (C x C)	—	—	3.15	4.13	4.92	5.71
H	1.73	1.73	1.93	2.28	2.80	3.19
Drain Port	1/4	1/4	1/4	1/4	1/2	1/2
A	1.41	1.41	1.57	1.96	2.52	2.95
B	0.59	0.59	0.70	0.90	1.14	1.42

Code No.16 (Fig. CYU)



15-014, 15-038, 15-012, 15-034, 15-100, 15-114

KITZ Code No. 15/16

Code No.60 (Fig. NO. AKGZH)
Threaded Ends



Gas Ball Valve

- Manual operated gas shut-off valves for appliances, appliance connector valve and hose end valves. The following agencies have certified these valves: AGA, CGA, ANSI, and ASME
- Forged Body Construction for Greater Strength
- Blowout-Proof Stem Design
- High Cycle Life PTFE Seats and NBR Seal
- Quarter Turn Open/Close Operation
- Positive Shutoff with Zero Leakage
- Rated for temperatures from -20° F to 125° F at pressures from 1/2 – 125 psi.

Wing Operator - KITZ Code # 60 (AKGZH)

Square Operator - KITZ Code # 60 SQ (AKGZHSQ)

60-012 or 60-034



Code No.07 (Fig. AKFS)



Code No.08 (Fig. CFS)



Class 125 Brass Gate Valve

Forged Brass Gate Valves have screwed-in-bonnet, non-rising stem, solid wedge disc, integral seat, NPT threaded or solder joint ends

** high tensile strength. Non-rising Stem permits installation where head space is limited.

Dimensions	inch				
Size	3/8	1/2	3/4	1	1-1/4
L (IPS)	1.50	1.65	1.85	1.97	2.36
L (C x C)	-	1.77	2.36	2.76	3.03
H	2.95	2.95	3.39	3.82	4.61
D	1.97	1.97	2.17	2.36	2.76

07-012, 07-034, 07-100

KITZ Code No. 07/08



Code No.58 (Fig. AKZA)



Code No.59 (Fig. CZA)



600 WOG "Full Port" Brass Ball Valves

Full Port Brass Ball Valves are two-piece construction with a chrome plated brass ball, blowout-proof stem, PTFE seats and double 'O' ring stem seal. Quick quarter-turn for easy operation. For use in plumbing and light industry applications. Standard NPT end connection.

Working Pressure	Test Pressure
600 psi W.O.G.	Shell 900 psi. hydrostatic
150 psi A 300° F	Seat 80 psi. air

Dimensions	inch					
Size	1/4	3/8	1/2	3/4	1	1-1/4
Bore	0.39	0.39	0.59	0.79	0.98	1.26
L (IPS)	1.57	1.61	1.93	2.20	2.56	2.99
L (C x C)	1.73	1.81	2.13	2.87	3.47	3.94
H	1.42	1.42	1.54	1.73	1.93	2.17
D	3.15	3.15	3.15	5.12	5.12	5.12

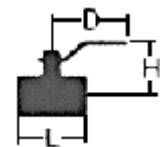

58-014, 58-038, 58-012, 58-034, 58-100, 58-114

58-112, 58-200

KITZ Code No. 58/59

CONDENSATE LINE ACCESSORIES

FlexConnect Couplings and Adapters

Available in a variety of sizes, the FlexConnect line is a no adhesive way to couple and adapt PVC lines to one another. 3/4" is especially convenient in the HVAC industry for condensate line service or repair



Flexcon34-6	6 pack of 3/4" PVC COUPLINGS
Flexcon-BULK	Box of 100 3/4" PVC COUPLINGS
FlexB-6	6 pack of 3/4" to 1/2" BUSHINGS
FlexCon1	1" COUPLING
FlexCon125	1.25" COUPLING
FlexCon150	1.5" COUPLING
FlexCon125150	1.25" to 1.5" ADAPTER
Flexcon2	2" COUPLING
Flexcon3	3" COUPLING
FlexCon23	2" to 3" ADAPTER

CONDENSATE LINE ACCESSORIES

CO2 Cartridges

Compatible with all industry drain line guns. 16 gram cartridges available both threaded and unthreaded; 12 pack in merchandise packaging or 100 in bulk. 20 gram available unthreaded in a 12 pack.



CO2-12 - 12 pack unthreaded 16 gram

CO2-100 - 100 pack unthreaded 16 gram

CO2-12T - 12 pack threaded 16 gram

CO2-20-12 - 12 pack unthreaded 20 gram



Drain Line Gun

Accepts all 16 gram cartridges, threaded or unthreaded.

DLG-1



Drain Line Gun XL

Accepts 20 gram CO2 cartridges.

This gun packs an extra punch!

DLG-2

ROTOLOCK VALVES, ADAPTERS, and ACCESSORIES

ESP offers the fullest line of rotolock valves, adapters, and accessories and a complete cross reference to most Copeland and Alfa/Standard Refrigeration parts. All valves and adapters are available with or without O-ring. If you purchase without, the TR-10 Teflon O-Ring kit contains three each of ALL sizes.

Part Number Key: E.g. H 038 OD 034 T

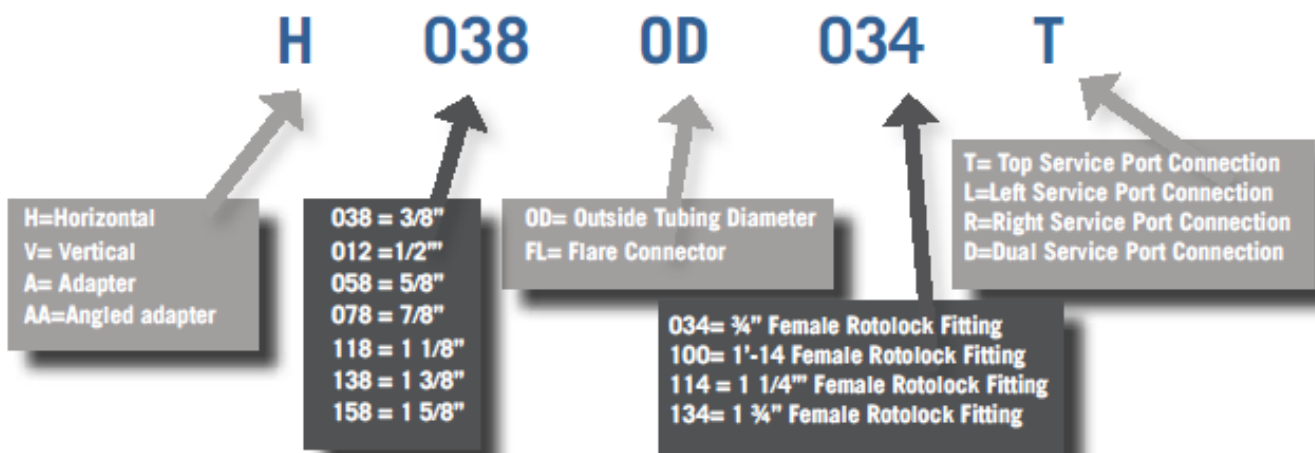

Service Port Connection Orientation

*Note Service Port connection left and right orientation determined by placing the valve with stem up, rotolock fitting facing up. This is a dual connection, with a upper left and lower right service port.



HORIZONTAL ROTOLock VALVES



HORIZONTAL ROTOLock

ESP #	ESP WITH O-RING	COPELAND	ALFA-LAVAL #
TOP PORT			TOP PORT
H038FL034T	H038FL034T-O		H03FT
H038OD034T	H038OD034T-O		
H012FL034T	H012FL034T-O		
H012FL100T	H012FL100T-O		H04FT
H058FL100T	H058FL100T-O		H0SFT
H0120D100T	H0120D100T-O		H04ST
H0580D100T	H0580D100T-O		H0SST
H034OD114L	H034OD114T-O		
H0780D114T	H0780D114T-O		H07ST
H1180D114T	H1180D114T-O		H09ST
H1180D134T	H1180D134T-O		H11ST
	H138OD134T-O	998-0510-66	
LEFT PORT			LEFT PORT
H038FL034L	H038FL034L-O		H03FL
H038FL100L	H038FL100L-O	998-0510-58	
H012FL100L	H012FL100L-O		H04FL
H058FL100L	H058FL100L-O		H0SFL
H0120D100L	H0120D100L-O		H04SL
H0580D100L	H0580D100L-O		H0SSL
H034OD114L	H034OD114L-O	998-0510-38	
H0780D114L	H0780D114L-O		H07SL
H1180D114L	H1180D114L-O	998-0510-51	H09SL
H1180D134L	H1180D134L-O		H11SL
	H158OD214L-O	998-0510-68	

HORIZONTAL ROTOLOCK VALVES



ALFA-LAVAL #	ESP #	ESP WITH O-RING	COPELAND
DUAL PORT			
	H038OD100D	H038OD100D-O	998-0510-97
	H038FL100D	H038FL100D-O	
	H038FL114D	H038FL114D-O	998-0510-42
	H038OD114D	H038OD114D-O	998-0510-43
	H012FL034D	H012FL034D-O	
	H012FL100D	H012FL100D-O	998-0510-40
	H012OD100D	H012OD100D-O	998-0510-98
	H012OD114D	H012OD114D-O	998-0510-44
	H058FL100D	H058FL100D-O	998-0510-41
	H058OD114D	H058OD114D-O	998-0510-45
	H034OD114D	H034OD114D-O	
	H078OD100D	H078OD100D-O	998-0510-89 & 52
RIGHT PORT			
H03FR	H038FL034R	H038FL034R-O	
H04FR	H012FL100R	H012FL100R-O	
H05FR	H058FL100R	H058FL100R-O	998-0510-56
H04SR	H0120 D100	H0120 D100-O	
H05SR	H058OD100R	H058OD100R-O	
		H078OD100R-O	998-0510-52
H07SR	H078OD114R	H078OD114R-O	998-0510-39 & 90
	H078OD134R	H078OD134R-O	
H09ST	H118OD114R	H118OD114R-O	998-0510-99
		H118OD134R-O	998-0510-02
	H138OD134R	H138OD134R-O	998-0510-46
		H158OD134R-O	998-0510-66

VERTICAL ROTOLock VALVES



**VERTICAL
ROTOLOCK**

ALFA-LAVAL #	ESP #	ESP WITH O-RING	COPELAND
TOP PORT			
V03FT	V038FL100T	V038FL100T-O	998-0510-58
V04FT			
V05FT			
V04ST	V0120D100T	V0120D100T-O	
V05ST	V0580D100T	V0580D100T-O	
V07ST	V0780D114T	V0780D114T-O	
V09ST	V1180D114T	V1180D114T-O	
V11ST	V138D134T	V138OD134T-O	
LEFT PORT			
V03FL			
V04FL			
V05FL			
V04SL	V0120D100L	V0120D100L-O	
V05SL	V0580D100L	V0580D100L-O	
V07SL	V0780D114L	V0780D114L-O	
V09SL	V1180D114L	V1180D114L-O	
V11SL	V130D134L	V130D134L-O	
H09SL	H1180D114L	H1180D114L-O	998-0510-51
H11SL	H1180D134L	H1180D134L-O	
		H158OD214L-O	998-0510-68
DUAL			
	V0120D100D	V0120D100D-O	
	V038OD034D	V038OD034D-O	
	V058OD100D	V058OD100D-O	
	V078OD114D	V078OD114D-O	
	V118OD114D	V118OD114D-O	
RIGHT PORT			
V03FR			
V04FR			
V05FR			
V04SR	V0120D100R	V0120D100R-O	
V05SR	V0580D100R	V0580D100R-O	
V07SR	V0780D114R	V0780D114R-O	
V09SR	V1180D114R	V1180D114R-O	

PAD VALVES



Two Bolt Flare Pad Valve



Two Bolt Sweat Pad Valve

ESP #	ESP WITH O-RING	COPELAND	ALFA-LAVAL #
TWO BOLT PAD VALVE			
PV012FLLH	2B12FL158L	998-0510-28	
PV58FLLH	2B58FL158L	998-0510-29	
PV02FLLH	2B12FL158R	998-0510-30	
PV058SWLH	2B58FL158R	998-0510-31	
PV038FLLH	2B38FL158L	998-0510-32	
PV014FLLH	2B14FL158L	998-0510-33	
PV058SWRH	2B58OD158R	998-0510-34	
PV038SWRH	2B38OD158R	998-0510-35	
PV038SWLH	2B38OD158L	998-0510-36	

SIGHT GLASS



ESP #	ESP WITH O-RING	COPELAND	ALFA-LAVAL #
SIGHT GLASS			
SG12			SG12
SG34			
SG10			
SG114			
SG20			
3/4"			



Angle Adapter Steel



Male Adapter Brass



Male Adapter Steel



Straight Adapter



Pad Adapter

ESP #	ESP WITH O-RING	COPELAND	AALFA-LAVAL #
STRAIGHT ADAPTER			
A0380D114	A0380D114-O		SA03
A0120D114	A0120D114-O		SA04
	A0120D100-O	998-0034-18	
	A0580D100-O	998-0034-17	
A0580D114	A0580D114-O		SA05
	A0340D114-O	998-0034-07	
A078D114	A078D114-O	998-0034-08	SA07
	A1180D114-O	998-0034-09	
A1380D134	A1380D134-O		SA11
	A1180D134-O	998-0034-10	
	A1380D134-O	998-0034-13	
	A1380D214-O	998-0510-11	
	A1580D214-O	998-0519-12	

ADAPTERS

ESP #	ESP WITH O-RING	COPELAND	ALFA-LAVAL #
MALE STEEL ADAPTER			
	MA038OS114-O	998-0034-14	
A012OD100M	MA012OS100-O	998-0034-15	
	MA058OD100-O	998-0510-16	
	MA034OD114-O	998-0034-01	
A078OD114M	MA078OD114-O	998-0034-02	
A118OD134M	MA118OD134-O		
ANGLE STEEL ADAPTER			
AA038OD100	AA038OD100-O		AA03
AA012OD100	AA012OD100-O		AA04
AA058OD100	AA058OD100-O		AA05
AA078OD114	AA078OD114-O		AA07
AA118OD114	AA118OD114-O		AA09
AA138OD134	AA138OD134-O		AA11
MALE BRASS ADAPTER			
7000-186	7000-186-O		BA03X06
7000-187	7000-187-O		BA03X08
7000-190	7000-190-O		BA04X08
N/A	N/A		BA05X08
7000-188	7000-188-O		BA07X10
7000-193	7000-193-O		BA09X10
7000-196	7000-196-O		B09X14
7000-200	7000-200-O		BA11X14

Rotolock Caps



Plastic Rotolock Caps



Steel Rotolock Caps

ESP #	COPELAND	AALFA-LAVAL #
ROTOLOCK CAPS		
3/4" rotalock cap, plastic (2/pk)		RC034-2
1" rotalock cap, plastic (2/pk)		RC100-2
1 1/4" rotalock cap, plastic (2/pk)		RC114-2
1 3/4" rotalock cap, steel (1/pk)		RC134-1

Teflon O-Rings

TR10-12 O-Ring Kit

ESP #	ALFA-LAVAL #	Description
TEFLON O-RINGS		
TR034-6	TS-24590	3/4 rotolock o-ring 6/pack
TR100-6	TS-24591	1" rotolock o-ring 6/pack
TR114-6	TS-24592	1 1/4" rotolock o-ring 6/pack
TR134-6	TS-24593	1 3/4" rotolock o-ring 6/pack
TR10-12	TR10	3 each, 3/4, 1" 1 1/4" and 1 3/4" o-rings



ESP delivers o-rings, o-ring kits, valve caps & kits, rotolock pad adapters, and gaskets.

Plus our gasket book — Finny's Gasket Book



This array of 36 different gaskets replaces most common gaskets used today in expansion and solenoid valves and pumps. This fine gasket material Garlock replaces old gaskets on Sporlan, Penn, Alco, Jackes Evans, Parker, Mueller, Hamilton Pax, Henry and Primore for a fraction of the price. Attractive counter pad with all 36 life-size gaskets available.

GB10



BRASS COMPRESSION FITTINGS



Brass Compression Fittings



Brass compression fittings can be used with copper, aluminum, brass, and plastic tube. Compatible with a wide variety of liquids and gases such as water, air, and fuels. Listed with U.L. for flammable liquid. Manufactured for low and medium pressure tubing connection work where excessive vibration or tube movement is not involved. Not recommended for application using gaseous media.

Working pressure ranges:

PSI	Tube OD	Tube Wall (inches)
400	1/8	.030
400	3/16	.030
300	1/4	.030
300	5/16	.032
200	3/8	.032
200	1/2	.035

Available in most configurations from 1/8" thru 5/8". Sleeves, nuts, unions, tees, adapters, elbows and other specials available on request.





Heresite Touch-Up Spray

This VR-554T air dry phenolic heresite spray is the highest quality metal protective coating sold in the U.S. today. Can be used to protect any surface subjected to corrosive atmospheres, 12 oz. Can.

VR-554



Rustoleum Spray Paint

Available in a variety of colors. 12 oz. unless specified. General purpose paint adheres to a variety of surfaces including wood, metal, and plastic.

3838506 - Flat Black (6/cs)

3838508 - Glossy Black (6/cs)

3838509 - Dove Gray (6/cs)

3843043 - High Heat Black (6/cs)

3843110 - Safety Yellow (6/cs)

429762 - Safety Red (6/cs) (15 oz.)

PERSONAL PROTECTIVE EQUIPMENT

HPPE Knit Gloves – Nitrile Palm



13-gauge High Performance Polyethylene knit shell. Micro-foam nitrile coated palm. Comfortable and superior performance. Meets current ASTM F2992-15 Standard for Cut Level A5

6773-02 - Medium (12/cs)

6773-03 - Large (12/cs)

6773-04 - XL (12/cs)

6773-05 - 2XL (12/cs)



Heavy Duty Professional Coveralls

Microporous non-woven material with polyethylene coating. Comfortable cloth-like fiber. Full zipper front. Elastic wrist and ankle cuffs. Meet ASTM F903-10 Chemical Penetration test for Solvent Based Paints.

6952 - Medium (24/cs)

6953 - Large (24/cs)

6954 - XL (24/cs)

6955 - 2XL (24/cs)

6956 - 3XL (24/cs)



Waterproof Shoe Covers

Durable, waterproof CPE material. Textured surface for better grip. Easy to put on and remove. Elastic opening for secured fit. Keeps shoes, boots and worksites clean

6884-06 - 6 pairs

6884-40 - 40 pairs



Raven 7 mil Nitrile Black Gloves

Powder-free exam grade nitrile. Non-latex. Outstanding strength, wear and dexterity. Textured for enhanced gripping power. 7 mil thick. 100 gloves per box

66517 - Medium

66518 - Large

66519 - XL

66520 - 2XL



Raven 7 mil Nitrile Hi Visibility Gloves

Powder-free exam grade nitrile. Non-latex. Outstanding strength, wear and dexterity. Textured for enhanced gripping power. High visibility green color. 7 mil thick. 100 gloves per box.

66551 - Medium

66552 - Large

66553 - XL

66554 - 2XL



Derma-Tuff Nitrile Gloves

Powder-free exam grade nitrile. Non-latex. Outstanding strength, wear and dexterity. Textured for enhanced gripping power. 6 mil thick. 100 gloves per box.

66587 - Medium

66588 - Large

66589 - XL

66590 - 2XL

CLEANING



Blue-Seamed Wiping Cloths

Heavy-duty blue seamed industrial cotton for any cleanup job. Available in 5 or 10lb. boxes.

WC05 (5lb.) or WC10 (10lb.)



Bad Ass Bags

42 gallon, 3 mil, black contractor trash bag with flaps.
Essential truck stock

CTB25— 25 count



Rough Touch **SCRUBS**



Scrubs-In-A-Bucket

Scrubs-in-a-bucket provide fast, easy and effective hand cleaning with portability. Pumice performance without gritty residue. Can be used with or without rinse. Removes grease, graphite, and even tar 6 per box.

SB72. 72 sheets, 10-1/4" x 12-1/4"



SB30

30 sheet, tool-box size

CLEANING



Handy Bucket and Bucket Seat

Available with both a wire and rope type handle, this 5 gallon bucket is a cut above the rest. The bottom side of the bucket has a handle which gives you something to grip when carrying, dumping, or moving tools, condensate blow out, or whatever your bucket may contain. Great price, top of the line quality - Made in the USA



BUCKET-5GW - 5 gallon bucket with wire handle with ESP logo (10/box)

BUCKET-5GR - 5 gallon bucket with rope handle with ESP logo (10/box)

BUCKETSEAT - Rotating seat that pairs perfectly with bucket (White)

BUCKETLID - White bucket lid with rieke spout



Universal Humidifier Solenoid

This universal solenoid can replace common units such as Aprilaire #4040, General's #990-53, Honeywell's #32001639-002, and the Skuttle #A01-0814-148 in 24V versions. The UHS will soon become an essential truck stock item. All appropriate fittings are included in the kit with a universal bracket. Flow can easily be reversed by removing two screws, turning the solenoid 180 degrees, and replacing the screws. 110V version is also available.

UHS24 or UHS120



UHS 99 Universal Humidifier Solenoid

UHS99

The UHS 99 can replace common units such as Aprilaire #4040, General's #990-53, Honeywell's #32001639-002, and the Skuttle #A01-0814-148 in 24V versions.

UHS99

HUMIDIFIER PARTS



Best Air Pro Water Pads

Best Air is the #1 selling humidifier water pad in the USA. These pads maximize humidity output and out perform all other pads. Our patented drip pattern, and 100% clay covered media is the difference. Replaces Aprilaire, Honeywell, Lasko, Hamilton, and Lennox.

A10PR, A12PR, A35PR



Humidifier Maintenance Kit

Includes humidifier feed tube, in line strainer, ¼" compression sleeve and nut. Kit includes everything you need to update humidifier feed tube.

HMK1



Smoke Emitters

Supplied in clean-to-handle cartridges and leave no visible residue. Smoke produced is easy to see and photograph if required. Oil-free smoke eliminates possible damage to decorations or equipment. Sizes are 45, 90, and 150 seconds 10/Box.

SE45, SE90, SE150

4 Minute and 8 minute smoke emitters

SE004 and SE008



Superior Smoke Emitters

Superior® Classic Smoke Candles quickly and efficiently produce dense white smoke. The Superior® #1A Smoke Candle generates 4000 cubic feet of smoke in thirty seconds. The Superior® #2B Smoke Candle generates 8000 cubic feet of smoke in sixty seconds. The Superior® #3C Smoke Candle generates 40,000 cubic feet of smoke over a 3+ minute burn duration.

1A (12/cs)

2B (12/cs)

3C (12/cs)



Smoke Check

SmokeCheck™, Smoke Detector Tester puts both photoelectric and ionization smoke detectors through their paces to ensure that the circuitry, alarm and power is functioning and that they are actively sampling the air for any hint of a fire. Our patented formulation simulates the entire range of fire conditions giving you the confidence of knowing your fire alarm system will respond promptly to all fire conditions. This product is approved for testing smoke detector function per NFPA 72 par. 8-2.4.1 when used as directed. Our SmokeCheck™, Smoke Detector Tester does not have HFC or CFC. Our products do not damage the Ozone layer and do not contribute to Global Warming. SmokeCheck™ has always been environmentally friendly. We did not change our products to comply with new codes or protocols. They were originally designed to be environmentally friendly. UL & ULC Listed, NFPA 72 Compliant, Safe on sensors.

SDT-25S





Unit Disposal Labels

6 labels per packet, Bright orange.

UD12



Industrial First Aid Kit

These 10, 25, 50 or 100 person weatherproof kits include all components listed in chart below

Contents:

Description	#10
Adhesive Strips	16
Large Wound Dressing	—
Gauze Pads 4 (3")	4
Gauze Bandage, 4" Eye	1
Pads	2
Adhesive Tape, 1/2"	1
Triangular Bandage	1
Elastic Bandage	—
Antiseptic Towelettes	10
First Aid Cream Packets	—
Aspirin	10
Eye Flush, 1 oz.	(1)*
Eye Flush, 4 oz.	—
Cold Pack	0
Latex Exam Gloves	2 pr.
Scissors	1
Forceps	1
First Aid Instructions	1



FA6060 (10 person)

The Sure Temp Product Thermometer



Is the least expensive device manufactured today to show exact product temperature in a case, reach-in or walk-in. The sensing probe itself is immersed in a glycol filled well that reacts to changes in ambient at the same rate as stored product. This assures the technician that he is reading internal product temperature and not surrounding air temperature.

The Sure Temp Thermometer is NSF certified and meets the criteria of Food Service.

Operating: Range is -40 degrees F to +180 degrees F. Dimensions are 1-5/15" X 6-7/8". Each unit comes with a bracket and screw for easy attachment to a rack or a panel. Each 10 unit case ships in an attractive counter display.

ST1236-31, (10 /display box)



AC Leaf & Debris Protector

This adjustable AC & Leaf Debris Protector, accommodates condensing unit sizes up to 4'x4' and covers all new high Seer residential units. It secures to the unit with heavy-duty elastic bands and makes spring cleaning easy 1/4" x1/4" openings.

ALDP

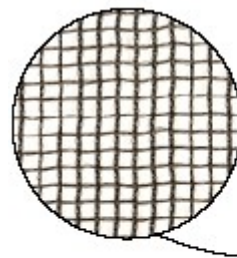

SPECIALTY



Oil Refractometer

This precise instrument is used to determine percentage of mineral oil in a refrigeration system during a POE (polyol ester) changeover. A brix scale, a refractive index, or any list of markings can be used to determine mineral oil percentage. ESP utilizes the brix scale. Copeland recommends a 5% mineral oil level as acceptable. At a 65.9 brix reading (E.S.P. Scale) or below, the residual mineral oil is at that safe level. No need to plot graphs. Easily understandable directions packed with the unit in a foam filled carrying case with oil dropper and calibration screw driver.

RHB-82 for POE unit

RHB-82-ND BVA Oil Refractometer

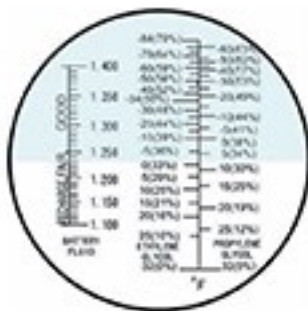

Glycol Refractometer

This instrument will give "good down to" temperatures for both ethylene and propylene glycol solutions, and an exact percentage of glycol calculation on the scale. Operates just like the oil refractometer in that the operator places a drop or two of solution on the Daylight Plate of the instrument, and then as he looks thru the eyepiece and focuses, a separation on the scale shows an accurate reading.

RHB-82G

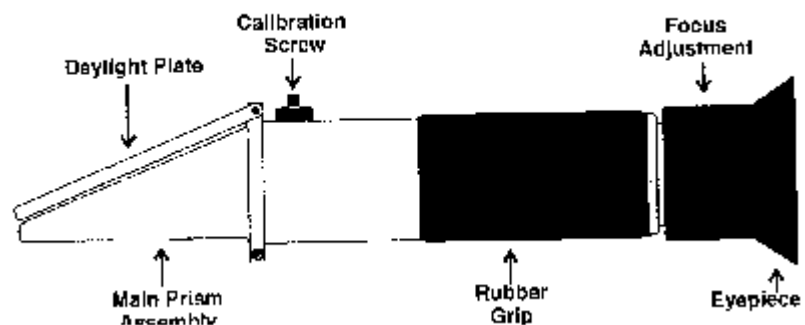



Thermo Plug

The Thermo Plug is a dual socketed temperature activated, single set point thermostat. Great for heat tapes, electric heaters, sump and tower heaters. Available in 35F and 50F.

THERMO PLUG #TP35



- Saves Energy - only operates when necessary.
- Red Power Indicator Light illuminates when power is on.
- Easy setup. The thermostat plugs into any standard outlet. No special wiring required. 120Volt 60Hz, Combined Maximum 15 amp and 1800 Watts.

- For indoor use only in residential or commercial applications.
- Follow the Heater Manufacturer Instructions before connecting the device.
- TP35 Turns a heater or other device on at approximately 35F (4C) and off at 45F when ambient temperature rises. TP50 turns on at 50F and off at 60F

THERMO PLUG #TP35

**The Thermo Plug is available in 35 F
(on at 35, off at 45)**

THERMO PLUG #TP50

**The Thermo Plug is available in 35 F
(on at 50, off at 60)**



Fast Stat

Upgrade your HVAC equipment without new wiring. Receiver and sender included. Run two stage equipment and more over two wire communication.

FSCM00 - Adds a common to a thermostat cable

FS1000 - Adds one wire to a thermostat cable

FS3000 - Adds two wires to a thermostat cable

FS5000 - Adds three wires and a common

FS7000 - Extends the wiring between a heat pump, indoor unit, and thermostat

FS9000 - Extends the wiring between a heat pump and indoor unit

HEAT GUNS, TORCHES, & ACCESSORIES



Master Heat Gun

Heavy-duty industrial quality heat gun with temperature and power ratings of 750° F (399°C) and 1680 watts (120V). The airflow rating is 23 CFM at 3,000 FPM. A universal motor, die cast aluminum housing, reinforced mica-insulated ceramic heating element, and externally replaceable carbon brushes make the Master Heat Gun a rugged, reliable source of flameless heat whether you're working with freezer coils, plastic laminates, circuit boards, PVC, fiberglass, or heat-shrinkable materials.

HG501A



ECOHEAT™ Heat Gun

An economical, low cost, entry level, multi-use heat gun. Perfect for industrial and commercial applications.

Features & Benefits:

- Two heat settings 500° and 1000°F, 120V, 10 Amps, 1200 Watts
- Lightweight (1 lb.), easy to hold at any angle for long periods
- Built-in hand guard, protects hands and fingers
- 3-Wire grounded cordset
- UL and CIL listed
- Thermoplastic case, for high impact durability

EC-200



Flame Guardian™

This unique non-asbestos flame-guard system protects wood, painted or metal surfaces from the heat and flame of a torch. This 9-1/2" x 12-1/2" pad with aluminum backing can be formed to any application.

FG12



Reusable Heat Blocker

Reusable heat trap in a can. Completely stops heat down ferrous or non-ferrous pipe. Easily molds to any shape. Removes quickly & cleanly after each application. No drip or mess. Good for 100 jobs. 12 oz. Jar.

HB34



Bussmann Limitron

U.L. listed for branch circuit protection, motor control circuits, lighting ballasts, and control transformers. Grooved ferrule permits mounting in rejection type fuseholders as well as standard non-rejection type.

KTK-R (600V) (1-30A)



Bussmann Glass and Specialty Fuses

ESP now makes these glass and specialty Buss fuses available to the diversified wholesaler.

**ABC 1-30; AGX 1-50; AGC 1/2 - 30; GLQ 3-10; C2 -2-1/2; GMF 1-5;
or No. 263-R; MDL 1-30**



FUSES

Bussmann Fusetron

These dual element, time delay fuses afford the same excellent overload protection of low-peak fuses of motors and other type loads having temporary inrush currents such as caused by transformers and solenoids.

FRN-R 250V and FRS-R 600V (2-1/2 - 200 A)

Bussmann low cost FRN-R replacements are also available.

ECNR10-100



Buss Fustat and Fustron Plug-In Fuses

Available in 1-1/4 thru 60 amp sizes.

S & SL (2-30A), SC (1-60A), Part # T & TL (1-1/4-30A)

Buss Fustat and Fustron Plug-In Fuses

Available in 1-1/4 thru 60 amp sizes.

S & SL (2-30A), SC (1-60A), Part # T & TL (1-1/4-30A)



Bussmann Fuse Holders

These four Bussmann fuse holders are now available for your HVAC needs.



- HPF - 10 /ctn
- HPS - 10 /ctn
- HRK- 10 /ctn



FB-2

FB-3



Bussmann Fuse Pullers

The safest, non-conductive tools used to remove fuse. Always remove power from fuse circuit before removing fuse.

- FP-2 for 13/32" to 13/16 dia. fuses
- FP-3 for 1" to 1-3/4" dia. fuses

Bussmann fused outlets, switches and receptacles

Also well stocked in our warehouse



- SSU (switch)
- SSY (fused receptacle)

Bussmann Blade type fuses

For P.C. board applications. Fast acting, 36V, UL recognized 3-40 A



- ATC 1 through ATC 40

ESP Wago Connectors

Be prepared to provide customers with everything they'll need for R290 and beyond. Pull the lever up, insert a conductor and push the lever back down – done! As tool-free, lever-actuated connectors, WAGO's 221 Series Splicing Connectors easily, quickly and safely connect solid, stranded and fine-stranded conductors ranging from 24–10 AWG.



NOTE: Wire nuts are not approved for R290. All connections must be UL approved such as a push and lock connectors for wire connections. These connectors must have sufficient strength to hold the wire in place.



Bulk Connectors in Brown Boxes

Part Number	# of Conductors	Connectors Per Box
221-412	2	100
221-413	3	50
221-415	5	25
221-2401	Butt Splice	60

10 Pack Connectors in Clamshells

Part Number	# of Conductors	Connectors Per Clam
221-412/996-010	2	10
221-413/996-010	3	10
221-415/996-010	5	10
221-2401/K000-0004	Butt Splice	10



Bulk ATC Fuses

25 pack of blade type fuses. 3 amp and 5 amp available. UL listed

EATC3-25 - 25 pack of ATC3 fuses

EATC5-25 - 25 pack of ATC5 fuses



ATM Fuses

Mini type blade fuses used on some residential equipment

ATM3 (5/cs)

ATM5 (5/cs)



ELECTRICAL PRODUCTS



Transition Terminals

To be used when control connectors don't match wire connections during replacements.

- Transition Terminals from .250 Female to .187 Male, and .187 Female to .250 Male

TT10 – 5 per pack



Tool Light Flashlight

This unique tool light slips onto the shaft of any screwdriver, 3/16"-7/16" lights up the work area with three LED. Just turn the grooved edge clockwise to turn on and off. Three magnets on the back will also hold it to the inside of your toolbox, or inside of a control compartment.

12 Per display box

TLFL





ESP Power Cords

ESP power cords are outdoor heavy capacity electrical cords, 12 or 14 gauge, 25', 50' or 100'.

- HC14-25, 50, 100**
- HC12-25, 50, or 100**



ESP Power Block

ESP Power Blocks are heavy duty, 3 outlet electrical cords. Plug three power tools or appliances into one outlet. Available in 12 or 14 gauge, 25', 50', or 100'.

- PB14-25, 50, or 100; PB12-25, 50, or 100**

ESP offers a premium quality TPE-rubber cord Power Block for extremely high and sub-zero temperatures. Available in 12 gauge with 2' cord.

- PD12-2**



ESP Light Bulbs

Light bulbs are now available in LED: 60W, 75W, 100W.

- RS60**
- RS75**
- RS100**

SPRAYERS



ESP Acid Blaster

This is the premium two gallon compression sprayer manufactured specifically with the AC&R contractor in mind. This sturdy unit incorporates a patented acid valve and utilizes viton gaskets which are chemical resistant. There are no metal parts that contact liquid. Unit has stainless pump rod and plate. The nozzle has adjustable spray levels. Order part # AB10. Repair kits include all gaskets and seals, part # 6-1925.

AB10



ESP Big Shot III.

This three gallon, acid resistant sprayer incorporates viton and polypropylene parts to minimize nuisance breakdowns and leakage. The wide angle, high delivery spray head provides quick application time and makes the coil cleaning job an easier one for your contractors.

BS30

Acid Blaster and Big Shot Replacement parts



6-6136, AB10 or BS30 Hose Assembly



6-1925 Gasket Kit



6-7748, AB10 or BS30 Wand



6-6003, AB10 or BS30 Nozzle



6-4626, AB10 or BS30 Handle



ESP "Tommy Gun"

Two quart compression sprayer made out of high pressure impact polyethylene. Equipped with adjustable spray nozzle, the Tommy Gun is lightweight and easy to use.

TG007



Tommy II

48 ounce sprayer in red, poly nozzle.

**TGII
3-1802 (Nozzle)**

ESP "Tommy Gun" Replacement Parts

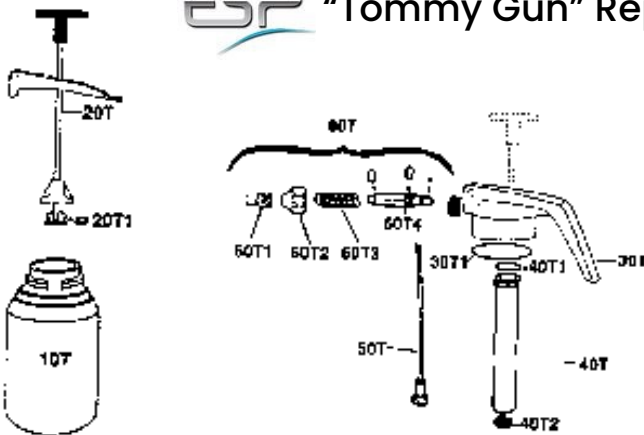

- 10T - Container only
- 20T - Plunger complete
- 20T1 - Plunger O-ring,
- 30T - Pump head only
- 30T1 - Container Sealing O-Ring,
- 40T - Pump barrel
- 40T1 - Sealing O-Ring,
- 40T2 - Non Return Valve
- 50T - Dip Tube & Filter
- 60T - Nozzle & Spindle Assembly,
- 60T4—Nozzle Spindle
- 90T - Complete Set of O-Rings and pump Non Return Valve.

SPRAYERS



Triple Shot Foamer

Unique foamer tip produces a large volume of clinging foam. Comfort-grip cushioned trigger delivers 3.5 ML per stroke (3-4 times vs. our general purpose units). 32 oz. clear bottle makes product recognition an easy task.

TS32 (12/cs)



High Delivery Sprayer

High delivery sprayer delivers 3.5 ML per stroke with adjustable nozzle and comfortgrip trigger. 32 oz. clear bottle to ease product recognition.

HD32 (12/cs)



Chem-Sprayer

This chemical resistant sprayer holds up against harsh chemicals and solvents that cause standard trigger sprayers to fail. Adjustable nozzle, o-ring, and piston cup are made of chemical resistant viton. 32 oz. clear bottle to ease product recognition.

CR32 (12/cs)



Industrial Sprayer

Economic design with extra long trigger for comfort. Provides average chemical resistance 24 oz. bottle.

IS005 (12/cs)



High Velocity Nozzle

100 psi max. Pistol grip. Heavy Duty

HVNI-25 / Case

SPRAYERS AND HOSES



Expanding Garden Hose

New and improved ESP black expanding hose expands to 50' when pressure is applied. When removed from pressure, the hose expels all water, avoiding a mess on the truck. Lightweight with heavy duty brass fittings plus shut off valve

BX50—30 / Case



Premium Rubber Garden Hose



ESP now offers premium rubber hoses. Standard lengths are 50' on both the black and high temperature red hoses. Both are flexible down to -40F. The red hose is rated for hot water use. Whether flushing hot water tanks, de-icing frosted coils, or just for general use, these made in the USA hoses are perfect for contractor's trucks.

Both style hoses are flexible to -40 F, have 400 psi burst pressure, and have heavy duty brass fittings.

The Red hose is rated for hot water



PRGH5825 – 25'
PRGH5850 – 50'
PRGH58100 – 100'



PRHWGH5850



Bulls Eye Nozzle

This carded adjustable hose nozzle, sprays a fine stream up to a solid heavy blast of water. Made of brass and stainless steel bearings.

810-C

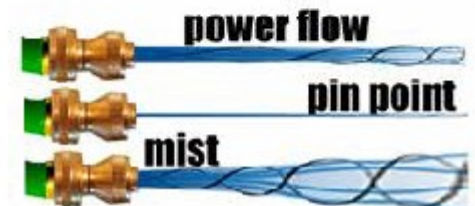



Diamond Vent Screens

These covers and caps prevent pest infestations, bird nests, and other nuisance issues on air intake and exhaust lines. 2", 3", and 4" PVC screens available. Concentric caps for 2" and 3" available

DVS-2

DVS-3

DVS-4

CV-2 DVS

CV-3 DVS



Mini Split Fitting

This is the next generation of AC MC connectors. They are designed to accommodate a broad range of cables. Each trade sized hub range overlaps the adjacent hub range, thereby minimizing the possibility of mismatched cables and fittings in the field

TECK50



Thermostat Guards

Polycarbonate and Steel versions available. Stainless Steel also available upon request. Mounting hardware included. 2 chrome plated keys included. Mount vertical or horizontal.

TP01CL - Polycarbonate mini

TP02CL - Polycarbonate small

TP03CL - Polycarbonate medium

TP04CL - Polycarbonate large

TP06M - Steel medium

TP07M - Steel large

TP08M - Steel mini

INSTALLATION ACCESSORIES

HVAC Service Center

The quickest way to power residential furnaces - Plus the benefit of a switch and a constantly powered GFI.

Pre-wired switch box comes with an always hot 15 amp GFCI and service switch. 8' whip connects switch box with junction box. 12 awg wire.

HVACSC-1

- 115 Volt
- 15 Amp
- Switch box comes pre-wired for an always hot GFI
- Switch controls power to equipment
- UL recognized components
- Fully Grounded
- 8' whip allows for easy mounting of junction box



EMT Connector (1)



Wire Nut (6)



Rommex Connector (1)



EMT One Hole Strap(3)



Greenfield Connector (1)

High Pressure Control Hoses

Captube / Superhose replacement. Great for refrigerant pressure sensing applications. 1000 psi working pressure rated. Approved for most refrigerants and oils. 2mm inside diameter. 1/4" SAE fittings



- HPCH18 - 18" STRAIGHT X 90 DEGREE**
- HPCH24 - 24" STRAIGHT X 90 DEGREE**
- HPCH30 - 30" STRAIGHT X 90 DEGREE**
- HPCH36 - 36" STRAIGHT X 90 DEGREE**
- HPCH48 - 48" STRAIGHT X 90 DEGREE**

High Pressure Control Hose Kit

This handy control hose kit includes 24' of 2MM hose, with cutter, crimper, and a wide assortment of over fifty straight, and 90 degree fittings. Also has core depressors, copper gaskets, everything a professional technician needs to make his own custom length hoses on site. No more wasted trips to the supply house. Essential to the upper echelon of contractors.

HPHK



2006-34



2007-41



2007-33



2006-38



2007-44



2026-14



2007-31



2001-26



2007-07



HPCH Control Hoses

REFRIGERATION

Natural Refrigerant Charging Hoses

Perfect for charging critically charged R290 or R600 units. Small diameter means minimal charge loss. 1/4" charging fittings



SH12KIT - 12" long set of 3 hoses STRAIGHT X 35 DEGREE

SH18KIT - 18" long set of 3 hoses STRAIGHT X 35 DEGREE

SH12Y - 12" long single hose STRAIGHT X 35 DEGREE

SH18Y - 18" long single hose STRAIGHT X 35 DEGREE

Oil Hoses

For applications that require oil flow as opposed to pressure sensing



522-0024-24 - 1/4 SAE STRAIGHT X 90 24" LONG

522-0024-36 - 1/4 SAE STRAIGHT X 90 36" LONG

533-0024-24 - 3/8 SAE STRAIGHT X 90 24" LONG

533-0024-36 - 3/8 SAE STRAIGHT X 90 36" LONG





Premium Refrigeration Fitting Brushes 900 Series Stainless Steel Wire

The highest quality fitting brush, double spiral 4-ply wire construction. Solid plastic hand fitting handle with convenient hole for hanging. Individual package.



OD REFRIGERATION SIZES				OD REFRIGERATION SIZES			
PART #	SIZE	PACK	WGT	PART #	SIZE	PACK	WGT
00924-1	1/4"	1	.04	00931-1	1-1/8"	1	.08
00925-1	3/8"	1	.08	00932-1	1-3/8"	1	.08
00926-1	1/2"	1	.08	00933-1	1-1/2"	1	.08
00927-1	5/8"	1	.08	00934-1	1-5/8"	1	.08
00928-1	3/4"	1	.08	00935-1	2-1/8"	1	.08
00929-1	7/8"	1	.08	00936-1	2-3/8"	1	.10
00930-1	1"	1	.08	00937-1	2-5/8"	1	.10

Premium Plumbing Fitting Brushes 900 Series Stainless Steel Wire

The highest quality fitting brush, double spiral 4-ply wire construction. Solid plastic hand fitting handle with convenient hole for hanging. Individual package.



OD REFRIGERATION SIZES				OD REFRIGERATION SIZES			
PART #	SIZE	PACK	WGT	PART #	SIZE	PACK	WGT
00943-1	1/8"	1	.04	00949-1	1"	1	.10
00944-1	1/4"	1	.08	00950-1	1-1/4"	1	.10
00945-1	3/8"	1	.08	00951-1	1-1/2"	1	.12
00946-1	1/2"	1	.10	00952-1	2"	1	.12
00947-1	5/8"	1	.10	00953-1	2-1/4"	1	.14
00948-1	3/4"	1	.110	00954-1	2-1/2"	1	.14

FITTING BRUSH SIZES & ACTUAL BRUSH DIAMETERS					
Fitting brushes are referred to by the size fitting they are designed to clean					
PLUMBING ID BRUSH AND FITTING SIZE	REFRIGERATION OD BRUSH AND FITTING SIZE	ACTUAL BRUSH DIAMETER	PLUMBING ID BRUSH AND FITTING SIZE	REFRIGERATION OD BRUSH AND FITTING SIZE	ACTUAL BRUSH DIAMETER
1/8"	1/4"	9/32"	1"	1-1/8"	1-3/16"
1/4"	3/8"	7/16"	1-1/4"	1-3/8"	1-7/16"
3/8"	1/2"	9/16"	1-1/2"	1-5/8"	1-3/4"
1/2"	5/8"	11/16"	2"	2-1/8"	2-1/4"
5/8"	3/4"	13/16"	2-1/4"	2-3/8"	2-1/2"
3/4"	7/8"	15/16"	2-1/2"	2-5/8"	2-3/4"

SCHAEFER BRUSH

2-IN-1 TOOL

A combination tool that fits your hand comfortably and really works. One end cleans the fitting; the other cleans the tub.



PART #	PLBG. ID SIZE	REFRIG. OD SIZE	PACK	WEIGHT
00996-12	1/2"	5/8"	12	1.44
00998-12	3/4"	7/8"	12	1.44
00996-100	1/2"	5/8"	100	12
00998-100	3/4"	7/8"	100	12

Outside Tube Cleaning Brush

Tough molded plastic holder with comfortable sure grip design and high carbon steel bristles. Packed 6 per box .



PART #	PLBG. ID SIZE	REFRIG. OD SIZE	PACK	WGT	PART #	PLBG. ID SIZE	REFRIG. OD SIZE	PACK	WGT
00963-6	1/8"	1/4"	6	.24	00967-6	3/4"	5/8"	6	.48
00964-6	1/4"	3/8"	6	.24	00968-6	7/8"	7/8"	6	.48
00965-6	3/8"	1/2"	6	.24	00969-6	1"	5/8"	6	.48
00966-6	1/2"	5/8"	6	.24	00970-6	1-1/8"	7/8"	6	.48

Nylon Tube Brush



PART #	DIA.X BRUSH PART	OAL	PACK	WGT	PART #	DIA.X BRUSH PART	OAL	PACK	WGT
14504	1/4" x 2"	6-1/2"	12	.7	14529	3/4" x 3"	9"	12	1.1
14506	1/4" x 2"	15"	12	.7	14530	3/4" x 3"	15"	12	1.3
14509	5/16" x 2"	15"	12	.8	14533	3/4" x 3"	30"	12	3.0
14510	3/8" x 2"	6-1/2"	12	.7	14539	1" x 4"	15"	12	1.5
14512	3/8" x 2"	15"	12	1.1	14547	1-1/4" x 4"	15"	12	1.5
14515	7/16" x 2"	15"	12	1.1	14565	1-1/2" x 4"	15"	12	1.8
14517	1/2" x 3"	9"	12	.9	14567	1-1/2" x 4"	36"	12	3.5
14518	1/2" x 3"	15"	12	1.1	14573	1-3/4" x 4"	15"	12	1.8
14520	1/2" x 3"	30"	12	3.0	14582	2" x 4"	15"	12	2.0
14524	5/8" x 3"	15"	12	1.1	14588	2-1/4" x 4"	36"	12	3.5

Natural Bristle or Hair



PART #	DIA.X BRUSH PART	OAL	PACK	WGT	PART #	DIA.X BRUSH PART	OAL	PACK	WGT
10209	1/4" x 2"	6-1/2"	12	.8	10212	3/4" x 3"	9"	12	1.1
10210	3/8" x 2"	6-1/2"	12	.8	10214	3/4" x 3"	12"	12	1.2
10220	3/8" x 2"	9"	12	.9	10213	1" x 4"	12"	12	1.3
10211	1/2" x 3"	9"	12	.8	10216	1" x 4"	18"	12	1.8
10221	1/2" x 3"	12"	12	1.1	10217	1-1/4" x 4"	18"	12	1.9
10222	1/2" x 3"	18"	12	1.2	10218	1-1/2" x 4"	18"	12	2.0
10223	1/2" x 3"	24"	12	1.3	10225	1-3/4" x 4"	18"	12	2.1
10224	1/2" x 3"	36"	12	2.3	10226	2" x 4"	18"	12	2.3

SCHAEFER
BRUSH

**LONG HANDLE STAINLESS STEEL
SINGLE SPIRAL TUBE BRUSHES - 144 SERIES**

3' brush part with long handle, filled with medium stiff wire.



EXACT					EXACT				
PART #	DIA.	OAL	PACK	WGT	PART #	DIA.	OAL	PACK	WGT
14402	1/4"	15"	1	.04	14442	1/4"	27"	1	.08
14404	3/8"	15"	1	.06	14444	3/8"	27"	1	.10
14406	1/2"	15"	1	.08	14446	1/2"	27"	1	.14
14408	5/8"	15"	1	.10	14448	5/8"	27"	1	.18
14410	3/4"	15"	1	.12	14450	3/4"	27"	1	.18
14412	7/8"	15"	1	.12	14452	7/8"	27"	1	.19
14414	1"	15"	1	.12	14454	1"	27"	1	.19
14416	1-1/4"	15"	1	.12	14456	1-1/4"	27"	1	.19
14418	1-1/2"	15"	1	.13	14458	1-1/2"	27"	1	.20



LARGE DIAMETER BRASS TUBE BRUSHES

Double stem with 1/4" male pipe thread.

BRUSH					BRUSH				
PART #	DIA.	LGTH	PACK	WGT	PART #	DIA.	LGTH	PACK	WGT
43636	1-1/4"	4-1/2"	1	.30	43653	2-3/4"	4-1/2"	1	.42
43639	1-1/2"	4-1/2"	1	.32	43656	3"	4-1/2"	1	.44
43642	1-3/4"	4-1/2"	1	.32	43658	3-1/4"	4-1/2"	1	.44
43645	2"	4-1/2"	1	.32	43660	3-1/2"	4-1/2"	1	.54
43648	2-1/4"	4-1/2"	1	.36	43662	3-3/4"	4-1/2"	1	.56
43651	2-1/2"	4-1/2"	1	.40	43664	4"	4-1/2"	1	.56



NYLON LARGE DIAMETER TUBE BRUSHES

Single stem with 1/4" male pipe thread.

BRUSH					BRUSH				
PART #	DIA.	LGTH	PACK	WGT	PART #	DIA.	LGTH	PACK	WGT
43736	1-1/4"	5"	1	.18	43753	2-3/4"	5"	1	.32
43739	1-1/2"	5"	1	.24	43756	3"	5"	1	.32
43742	1-3/4"	5"	1	.24	43758	3-1/4"	5"	1	.34
43745	2"	5"	1	.26	43760	3-1/2"	5"	1	.38
43748	2-1/4"	5"	1	.26	43762	3-3/4"	5"	1	.44
43751	2-1/2"	5"	1	.32	43764	4"	5"	1	.44

SCHAEFER BRUSHES



REFRIGERATOR COIL DUSTING & CLEANING BRUSHES

Used to clean refrigerator coils, fan blades and areas under and behind appliances.



PART #	MATERIAL	STEM DIA.	DESCRIPTION	PK.	WT.
00405	Bristle	.200	3/4" & 1-1/2" x 12" BR. 15" Wood HDL. 28" O.A.L.	36	8.2
00415	Bristle	.200	Same as 00405 in single box	1	.44
50405	Bristle	.200	Same as 00405 on 4-color card	10	3.3
00406	W. Poly	.225	3/4" & 1-1/2" x 12" BR. 4-1/2" Wood HDL. 28" O.A.L.	36	9.8
00416	W. Poly	.225	Same as 00406 in single box	1	.48
00408	Bristle	.200	3/4" to 1-1/2" taper x 12" BR. 4-1/2" Wood HDL. 27" O.A.L.	36	9.2
00402	Bristle	.200	2" x 6" BR. x 24" O.A.L.	36	8.2
00403	Bk. Poly	.225	3/4" to 1-1/2" taper x 12" BR. 2-1/4" x 7" Br. x 24" O.A.L.	36	9.2

DUCT CLEANING BRUSH

7" long brush part with twisted wire stem and plastic, or wood handle.



PART #	MATERIAL	BRUSH DIA.	OVERALL LENGTH	PACK	WGT
76200	Cr. Brass Wire	2-1/8"	48"	1	.44
76210	Stainless Steel	2-1/8"	48"	1	.50
76220	Black Pat. Fibre	2-1/8"	48"	1	.40

FIBRE/HAIR MIX FURNACE & BOILER BRUSHES

7624 SERIES

Extra heavy fill, 6" long brush part with twisted wire handle and large loop end.



PART #	BRUSH DIA.	OVERALL LENGTH	PACK	WGT
76243	3"	27"	1	.34
76245	2"	42"	1	.44

RADIATOR OR REFRIGERATOR BRUSHES

Black natural bristle, twisted in wire with loop end.



PART #	STEM DIA.	BRUSH DIA.	OVERALL LENGTH	BRUSH LENGTH	PACK	WGT
00450	.200	1/2" to 1"	36"	7"	12	3.36
00442	.225	1" to 2"	42"	7"	12	4.56



RADIATOR DUSTING & CLEANING BRUSH

Twisted in wire with plastic handle at end.



PART #	MATERIAL	BRUSH LENGTH	BRUSH DIA.	OVERALL LENGTH	PACK	WEIGHT
76221	Bristle or Hair	7"	2"	27"	1	.22
76324	Black Horsehair	7"	2-1/2"	27"	1	.22
76524	HH/Poly Mix	7"	2-1/2"	27"	1	.22

LONG WOOD HANDLE DUSTING BRUSH W/FLARED TIP

One row, curved lacquered wood handle



PART #	MATERIAL	BRUSH LENGTH	BRUSH TRIM	OVERALL LENGTH	PACK	WEIGHT
76026	Horsehair	10"	2-1/4"	24"	1	.26

NYLON SINGLE SPIRAL

CONDENSER TUBE BRUSHES – 437 & 937 SERIES



Single spiral/single stem construction recommended for cleaning all tubes where deposits are light. 1/4" and 5/16" dia. brushes with female couplings have 8-32 threads, while 3/8" thru 1" dia. have 12-24 threads. 1/4", 5/16", and 3/8" dia. brushes with male couplings have 8-32 threads, while 7/16" thru 1" dia. have 1/4-28 threads.



BRUSH DIA.	BRUSH LENGTH	FEMALE THREAD	FEMALE PART	MALE THREAD	MALE PART	PACK	WEIGHT
1/4"	3"	8-32	43702	8-32	93702	1	.04
5/16"	3"	8-32	43703	8-32	93703	1	.04
3/8"	4"	12-24	43704	8-32	93704	1	.08
7/16"	4"	12-24	43707	1/4-28	93707	1	.10
1/2"	4"	12-24	43710	1/4-28	93710	1	.10
9/16"	4"	12-24	43713	1/4-28	93713	1	.10
5/8"	4"	12-24	43716	1/4-28	93716	1	.10
11/16"	4"	12-24	43719	1/4-28	93719	1	.10
3/4"	4"	12-24	43722	1/4-28	93722	1	.10
13/16"	4"	12-24	43725	1/4-28	93725	1	.10
7/8"	4"	12-24	43728	1/4-28	93728	1	.10
15/16"	4"	12-24	43731	1/4-28	93731	1	.10
1"	4"	12-24	43733	1/4-28	93733	1	.10



**BRASS SINGLE SPIRAL CONDENSER
TUBE BRUSHES- 436 & 936 SERIES**

Single spiral/double stem construction recommended for brass or copper tubes. 1/4" and 5/16" dia. brushes with female couplings have 8-32 threads, while 3/8" thru 1" dia. have 12-24 threads. 1/4", 5/16", and 3/8" dia. brushes with male couplings have 8-32 threads, while 7/16" thru 1" dia. have 1/4-28 threads.



BRUSH DIA.	BRUSH LENGTH	FEMALE THREAD	FEMALE PART	MALE THREAD	MALE PART	PACK	WEIGHT
1/4"	3"	8-32	43602	8-32	93602	1	.06
5/16"	3"	8-32	43603	8-32	93603	1	.06
3/8"	4"	12-24	43604	8-32	93604	1	.10
7/16"	4"	12-24	43607	1/4-28	93607	1	.10
1/2"	4"	12-24	43610	1/4-28	93610	1	.10
9/16"	4"	12-24	43613	1/4-28	93613	1	.14
5/8"	4"	12-24	43616	1/4-28	93616	1	.14
11/16"	4"	12-24	43619	1/4-28	93619	1	.14
3/4"	4"	12-24	43622	1/4-28	93622	1	.14
13/16"	4"	12-24	43625	1/4-28	93625	1	.16
7/8"	4"	12-24	43628	1/4-28	93628	1	.16
15/16"	4"	12-24	43631	1/4-28	93631	1	.16
1"	4"	12-24	43633	1/4-28	93633	1	.16

STAINLESS STEEL SINGLE SPIRAL - 435 & 935 SERIES

Single spiral/double stem construction recommended for stainless steel tubes. 1/4" and 5/16" dia. brushes with female couplings have 8-32 threads, while 3/8" thru 1" dia. have 12-24 threads. 1/4", 5/16", and 3/8" dia. brushes with male couplings have 8-32 threads, while 7/16" thru 1" dia. have 1/4-28 threads.



BRUSH DIA.	BRUSH LENGTH	FEMALE THREAD	FEMALE PART	MALE THREAD	MALE PART	PACK	WEIGHT
1/4"	3"	8-32	43502	8-32	93502	1	.02
5/16"	3"	8-32	43503	8-32	93503	1	.06
3/8"	4"	12-24	43504	8-32	93504	1	.10
7/16"	4"	12-24	43507	1/4-28	93507	1	.10
1/2"	4"	12-24	43510	1/4-28	93510	1	.10
9/16"	4"	12-24	43513	1/4-28	93513	1	.10
5/8"	4"	12-24	43516	1/4-28	93516	1	.14
11/16"	4"	12-24	43519	1/4-28	93519	1	.14
3/4"	4"	12-24	43522	1/4-28	93522	1	.14
13/16"	4"	12-24	43525	1/4-28	93525	1	.14
7/8"	4"	12-24	43528	1/4-28	93528	1	.14
15/16"	4"	12-24	43531	1/4-28	93531	1	.16
1"	4"	12-24	43533	1/4-28	93533	1	.16



TIN HANDLE ACID & DOPE BRUSHES

Selected horsehair bristles are pressed securely in tin handles. Sold in gross packs only.



PART #	BRUSH WIDTH	HANDLE LENGTH	PACK	WEIGHT
10001	3/8"	5"	144	2.14
10002	1/2"	5"	144	2.64
10003	5/8"	5"	144	3.30

WOOD HANDLE DOPE BRUSH

Selected horsehair bristles secured tightly in metal ferrule. Sold in packs of 36.



PART #	BRUSH WIDTH	OVERALL LENGTH	BRUSH MATERIAL	PACK	WEIGHT
10007	3/4"	7"	Horsehair	36	1.34

IMPORT WHITE BRISTLE CHIP BRUSHES

White Chinese bristle, metal ferrule. Plain sanded wood handle. Low priced economy import.



PART #	WIDTH	THICKNESS	TRIM	PACK	WEIGHT
67191	1/2"	1/4"	1-3/8"	36	.72
67192	1"	5/16"	1-5/8"	36	1.44
67193	1-1/2"	5/16"	1-5/8"	36	1.44
67194	2"	5/16"	1-5/8"	24	1.44
67195	2-1/2"	3/8"	1-5/8"	24	2.40
67196	3"	3/8"	1-5/8"	24	2.40
67197	4"	11/16"	1-5/8"	12	3.84

IMPORT BLACK BRISTLE CHIP

Black Chinese bristle in a chemical resistant plastic handle.



PART #	WIDTH	THICKNESS	TRIM	PACK	WEIGHT
67230	1/2"	1/4"	1-3/8"	1	.02
67231	1"	5/16"	1-5/8"	1	.04
67232	1-1/2"	5/16"	1-5/8"	1	.06
67233	2"	5/16"	1-5/8"	1	.06
67234	2-1/2"	3/8"	1-5/8"	1	.10
67235	3"	3/8"	1-5/8"	1	.10



WIRE HANDLE CHIP BRUSHES

Ideal for cleaning rust, corrosion, etc. in high heat situations.



PART #	FILL	TRIM	OVERALL LENGTH	PACK	WEIGHT
81616	C. Steel	1-1/2"	5-1/2"	1	.10
81617	St. Steel	1-1/2"	5-1/2"	1	.10

FLAT OIL /CHIP BRUSH

Absorbent natural tampico or poly in a twisted wire handle with ring end. Overall length 8-1/4".



PART #	BRUSH MATERIAL	BRUSH WIDTH	BRUSH LENGTH	PACK	WEIGHT
24800	Tampico	2-1/4"	3"	1	.08
67118	Poly	2-1/4"	3"	1	.06

CONDENSER FIN WHISK, DUSTERS & UPRIGHT BROOMS

Plastic handle whisk for cleaning condenser fins and evaporators - A whisk with a hundred uses.



PART #	BRUSH WIDTH	TRIM	OVERALL LENGTH	PACK	WEIGHT
02026	3-1/8"	2-1/8"	7"	1	.04

Fin and Plenum Brush

The fin and plenum brush - has a 14", extra long handle. The total length of the brush is 18". Bristles are 2" wide, all natural. It's perfect for cleaning coils, and is especially useful for applying mastic and other sealants in hard to reach places.



RAD2 - 12/CS

BENCH DUSTER

Tough and durable brush available in tampico and horsehair.



PART #	MATERIAL	BRUSH FACE	OVERALL LENGTH	TRIM	PACK	WEIGHT
62034	Tampico	2" x 8"	14"	2-5/8"	1	.66



POLYESTER VARNISH BRUSH

Durable black polyester filament with a solvent resistant plastic handle.



PART #	WIDTH	THICKNESS	TRIM	PACK	WEIGHT
67240	1/2"	1/4"	1-5/8"	1	.02
67241	1"	5/16"	1-3/4"	1	.04
67242	1-1/2"	5/16"	1-3/4"	1	.06
67243	2"	5/16"	1-3/4"	1	.08
67244	2-1/2"	3/8"	2"	1	.10
67245	3"	3/8"	2"	1	.12

PARTS CLEANING BRUSH

Tampico or Poly fill in strong plastic handles, comes in standard or flow thru style.



PART #	BRUSH MATERIAL	OVERALL LENGTH	PACK	WEIGHT
25010	Poly	11-5/8"	1	.17
*25095	Poly	9"	1	.17
25013	Tampico	11-5/8"	1	.17
25015	All Poly	10-3/4"	1	.14

*25095 is a Flow-Thru model.

SHOE HANDLE WIRE HAND BRUSH

10" hardwood handle filled with tempered steel, stainless steel, bronze, brass, fibre or poly.



PART #	FILL	ROWS	FILL SIZE	BRUSH PART	PACK	WEIGHT
81232	T Steel	2 x 17	.012	5"	1	.20
81233	T Steel	3 x 17	.012	5"	1	.28
81234	T Steel	4 x 17	.012	5"	1	.38

SCHAEFER
BRUSH

CURVED HANDLE WIRE HAND BRUSHES

14" hardwood handle filled with tempered steel, stainless steel, bronze, brass, fibre or poly.



PART #	FILL	ROWS	FILL SIZE	BRUSH PART	PACK	WEIGHT
*65341	Brass	4 x 17	.003	3-1/4"	1	.19
55104	Tampico	4 x 19	n/a	6-1/2"	1	.32
55105	Poly	4 x 19	.020	6-1/2"	1	.14
81008	T Steel	2 x 18	.012	6-1/2"	1	.22
81009	T Steel	3 x 19	.012	6-1/2"	1	.32
81010	T Steel	4 x 18	.012	6-1/2"	1	.42
81018	St. Steel	3 x 19	.012	6"	1	.22
81020	St. Steel	4 x 18	.012	6"	1	.38
81025	Bronze	4 x 18	.014	6"	1	.46
81044	Brass	3 x 19	.006	6"	1	.34
81045	Brass	4 x 19	.006	6"	1	.46

*65341 has a straight, 8-3/4" long handle with a 3-1/4" brush part and 3/4" trim

STOVE & APPLIANCE BRUSH

2 X 9 rows, 5/8" trim. 8-5/8" long hardwood block with 2-7/8" long brush part.



PART #	FILL	ROWS	TRIM	OVERALL LENGTH	PACK	WEIGHT
25301	St. Steel	2 x 9	5/8"	8-5/8"	1	.08
25302	Brass	2 x 9	5/8"	8-5/8"	1	.08

DIE CAST BRUSHES

3 X 7 rows, 1/2" trim. 7" long plastic block with 1-1/2" long brush part.



PART #	FILL	ROWS	TRIM	OVERALL LENGTH	PACK	WEIGHT
25404	St. Steel	3 x 7	1/2"	7"	1	.04
25405	Brass	3 x 7	1/2"	7"	1	.04
25406	Bronze	3 x 7	1/2"	7"	1	.04
25407	Nylon	3 x 7	1/2"	7"	1	.04



WELDER'S WIRE HAND BRUSH

3 X 7 rows, 1/2" trim. 8" long hardwood block with 1-1/2" long brush part.



PART #	FILL	ROWS	TRIM	OVERALL LENGTH	PACK	WEIGHT
81002	St. Steel	3 x 7	1/2"	8"	1	.04
81003	Brass	3 x 7	1/2"	8"	1	.04
81005	Nylon	3 x 7	1/2"	8"	1	.04
81006	Horsehair	3 x 7	1/2"	8"	1	.04



BRASS WIRE UTILITY BRUSHES

Curved hardwood block with crimped brass wire.

PART #	FILL	ROWS	TRIM	BRUSH PART	PACK	WEIGHT
27698	Brass	6 x 9	5/8"	1-1/4" x 2-1/4"	1	.18
27668	Brass	9 x 10	5/8"	2-1/4" x 3"	1	.36

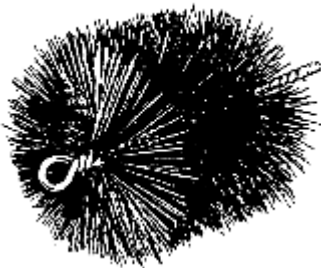

PROFESSIONAL CHIMNEY BRUSHES

All our professional chimney brushes have extra heavy 1/2" dia. stems, constructed with four lengths of .162 dia. galvanized steel wire. Plated shaft with 3/8" male pipe threads are secured to the stems for easy coupling to our heaviest fiberglass rods.

MASTER CLEAN

Fully filled with round tempered steel wire using double spiral construction. These premium brushes have been the choice of many professional chimney sweeps for years.



ROUND				SQUARE			
PART #	SIZE	PACK	WEIGHT	PART #	SIZE	PACK	WEIGHT
33066	6"	1	1.90	33277	7"	1	2.10
33076	7"	1	2.00	33288	8"	1	2.10
33086	8"	1	2.10	33299	9"	1	2.60
33096	9"	1	2.50	33310	10"	1	2.80
33106	10"	1	2.60	33311	11"	1	2.90
33116	11"	1	2.70	33312	12"	1	3.10
33126	12"	1	2.80	33314	14"	1	3.40
33266	6"	1	2.00				



FLUE, DUCT, CHIMNEY RODS & T-HANDLES



PART #	PIPE THREAD	PACK	WEIGHT
30599	1/4"	1	.22
30600	3/8"	1	.24

FLUE BRUSH HANDLE

Semi-flexible, twisted galvanized wire with one female end and 1" ring at other end.



PART #	HANDLE LENGTH	PACK	WEIGHT
30328	3"	1	.56
30438	4"	1	.70
30548	5"	1	.86
30658	6"	1	1.06

FIBERGLASS RODS

Strong extruded fiberglass rods in a variety of diameters provide the proper stiffness for most jobs. We recommend using these nonconducting fiberglass rods whenever possible.

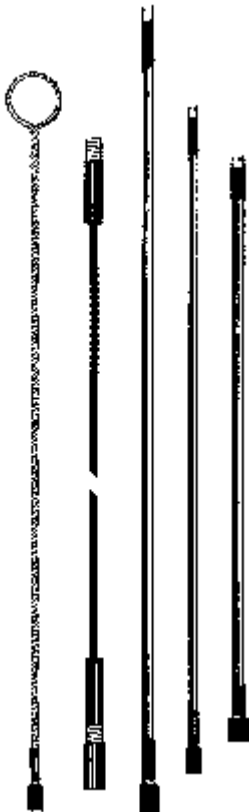

PART #	DIA.	LENGTH	PIPE THREAD	PACK	WEIGHT
30664	.350	4'	1/4"	1	.42
30666	.350	6'	1/4"	1	.68
36048	.440	4'	3/8"	1	.66
36072	.440	6'	3/8"	1	.92
30660	.480	6'	3/8"	1	1.24

EXTENSION HANDLES

Semi-flexible, twisted galvanized wire with female one end and male other.

PART #	HANDLE LENGTH	PACK	WEIGHT
31438	4'	1	.78
31448	5'	1	.92
31458	6'	1	1.04



TEMPERED WIRE SINGLE SPIRAL FLUE BRUSHES

4-1/2" long tempered wire brush part, 1/4" male pipe thread.



PART #	FLUE SIZE	BRUSH DIA.	PK.	WT.	PART #	FLUE SIZE	BRUSH DIA.	PK.	WT.
43206	1"	3/4"	1	.28	43224	2-3/4"	2-1/2"	1	.42
43208	1-1/4"	1"	1	.30	43226	3"	2-3/4"	1	.44
43212	1-1/2"	1-1/4"	1	.32	43228	3-1/4"	3"	1	.46
43214	1-3/4"	1-1/2"	1	.34	43232	3-1/2"	3-1/4"	1	.48
43216	2"	1-3/4"	1	.36	43234	3-3/4"	3-1/2"	1	.50
43218	2-1/4"	2"	1	.38	43236	4"	3-3/4"	1	.52
43222	2-1/2"	2-1/4"	1	.40	43238	4-1/4"	4"	1	.54

TEMPERED WIRE – DOUBLE SPIRAL

4-1/2" long tempered wire brush part, 1/4" male pipe thread. Brushes are individually boxed.



PART #	FLUE SIZE	BRUSH DIA.	PK.	WT.	PART #	FLUE SIZE	BRUSH DIA.	PK.	WT.
43306	1"	3/4"	1	.30	43324	2-3/4"	2-1/2"	1	.44
43308	1-1/4"	1"	1	.32	43326	3"	2-3/4"	1	.46
43312	1-1/2"	1-1/4"	1	.34	43328	3-1/4"	3"	1	.48
43314	1-3/4"	1-1/2"	1	.36	43332	3-1/2"	3-1/4"	1	.50
43316	2"	1-3/4"	1	.38	43334	3-3/4"	3-1/2"	1	.52
43318	2-1/4"	2"	1	.40	43336	4"	3-3/4"	1	.54
43322	2-1/2"	2-1/4"	1	.42	43338	4-1/4"	4"	1	.56

STAINLESS STEEL – SINGLE SPIRAL FLUE BRUSHES

4-1/2" long brush part, 1/4" male pipe thread. Brushes are individually boxed.



PART #	FLUE SIZE	BRUSH DIA.	PK.	WT.	PART #	FLUE SIZE	BRUSH DIA.	PK.	WT.
43536	1-1/2"	1-1/4"	1	.36	43559	3-1/2"	3-1/4"	1	.52
43539	1-3/4"	1-1/2"	1	.38	43562	3-3/4"	3-1/2"	1	.54
43542	2"	1-3/4"	1	.40	43565	4"	3-3/4"	1	.56
43545	2-1/4"	2"	1	.42	43568	4-1/4"	4"	1	.58
43548	2-1/2"	2-1/4"	1	.44	43571	4-1/2"	4-1/4"	1	.60
43551	2-3/4"	2-1/2"	1	.46	43573	4-3/4"	4-1/2"	1	.62
43553	3"	2-3/4"	1	.48	43576	5"	4-3/4"	1	.64
43556	3-1/4"	3"	1	.50	43579	5-1/4"	5"	1	.66



FLAT BAFFLE BOILER BRUSH

Double spiral, black oil tempered wire brush part with 1/4" male pipe thread. Brushes are individually boxed.



PART #	BRUSH SIZE	BRUSH LENGTH	PK.	WT.
41218	1"	4-1/2"	1	.16
41228	2"	4-1/2"	1	.30
41238	3"	4-1/2"	1	.38
41248	4"	4-1/2"	1	.44

ORIGINAL COLUMBIA BOILER BRUSH

Bristles stick out in all directions and are rough cut to a rectangular shape, approximately 1/2" x 1". Much lighter fill than the flat style.



PART #	BRUSH SIZE	HANDLE LENGTH	PACK	WEIGHT
46328	1/2" x 1" x 4"	3'	1	.36
46348	1/2" x 1" x 4"	4'	1	.46

FLAT STYLE COLUMBIA BOILER BRUSH

Bristles stick out to the 1" dimension as round brush is flattened after being made



PART #	BRUSH SIZE	OVERALL LENGTH	PACK	WEIGHT
46302	1/2" x 1" x 4-1/2"	27"	1	.41
46304	1/2" x 1" x 4-1/2"	48"	1	.72

WEILER MCLAIN BOILER BRUSH

1-1/2" x 1-1/8" x 4" oval shaped brush with crimped carbon steel or soft bristle. Long twisted wire handles with 1" ring end.



PART #	MATERIAL	HANDLE DIA.	O.A.L.	PK.	WT.
14465	Crimped Wire	.20	30"	1	.32
14466*	Crimped Wire	.25	30"	1	.34
14467	Bristle	.20	30"	1	.40
14468*	Crimped Wire	.25	46"	1	.46
14476	Crimped Wire	.135	30"	1	.12
14477	Bristle	.135	30"	1	.10

EXTRA LONG HANDLE/STIFF WIRE BRUSHES- 7625 SERIES

Single spiral fine wire brush part 4" long, twisted in wire handle with loop end. 42" overall length.



PART #	BRUSH SIZE	OVERALL LENGTH	PACK	WEIGHT
76252	1/2"	42"	1	.26
76253	3/4"	42"	1	.28
76254	1"	42"	1	.44
76255	1-1/2"	42"	1	.46
76256	2"	42"	1	.50
76257	2-1/2"	42"	1	.52
76258	3"	42"	1	.54



SPIN-GRIT™

Single stem construction with silicone carbide impregnated nylon recommended for brass tubes. This brush is made oversized so the filament will lay over, resulting in increased contact with surface, providing better cleaning and longer life than conventional condenser cleaning brushes.



BRUSH DIA.	TUBE SIZE	FEMALE THREAD	FEMALE PART #	MALE THREAD	MALE PART #	PK.	WT.
1/2"	1/4" - 5/16"	8-32	43482	8-32	93482	1	.02
3/4"	3/8" - 9/16"	12-24	43484	1/4-28	93484	1	.06
1"	5/8" - 11/16"	12-24	43486	1/4-28	93486	1	.06
1 1/4"	3/4" - 1"	12-24	43488	1/4-28	93488	1	.07

SPIN-CLEAN™

Single stem construction with silicone carbide impregnated nylon. This brush is made with a tapered trim to allow better cleaning of enhanced condenser tubes. The long bristles are designed oversized with the intention of bending over, allowing the aggressive filament to come into maximum contact with the lands. The short bristles are able to get into the grooves. These brushes provide better cleaning and longer life than conventional condenser cleaning brushes.



PART #	TUBE SIZE	SMALL DIA. OF BRUSH	LARGE DIA. OF BRUSH
93490	5/8"	5/8"	1"
93491	1/2"	1/2"	3/4"
93492	3/4"	3/4"	1-1/8"



RODS & ROD HANDLES



- #13000 – “T” handgrip handle with 1/4-28 cap nut. 4” long x 1/2” diameter. For use with #13010 rods.
- #13001 – “T” handgrip handle with 12-24 screw. 4” long x 1/2” diameter. For use with #13002 and #13003 rods.
- #13002 – 24” aluminum extension rod 5/16” diameter with 12-24 male thread one end, female other. For use with 3/8” through 1” diameter condenser brushes.
- #13003 – 36” aluminum extension rod 5/16” diameter with 12-24 male thread one end, female other. For use with 3/8” through 1” diameter condenser brushes.
- #13010 – 36” galvanized steel condenser brush rod with 1/4-28 male thread one end and female thread at other end. For use with 1/4-28 male thread brushes.
- #13041 – “T” handle with 8-32 male thread one end. For use with #13042 rods.
- #13042 – 24” x .162 dia. rod, 8-32 female thread one end, male 8-32 thread other end.
- #13044 – 48” x .162 dia. rod with 8-32 male thread one end, formed handle other end. For use with 1/4” and 5/16” dia. condenser brushes.

ADAPTERS

- #13006 – 1/4-28 male thread to 12-24 male thread
- #13008 – 1/4-28 female thread to 12-24 male thread



CLEVELAND CONTROLS AIR PRESSURE SENSING SWITCH

The model AFS-222 and AFS-262 are a general purpose proving switch designed for HVAC and Energy Management applications. It may be used to sense positive, negative, or differential air pressure. Installation kit included. Replaces White Rodgers 770-1.

Set point range: 0.05 + .02" W.C. to 12.0" W.C.
 Operating temperature range: -40°F to 180°F
 Approvals: UL, FM, CSA

AFS-222-121

AFS-262-121



SERIES AFS SWITCHES

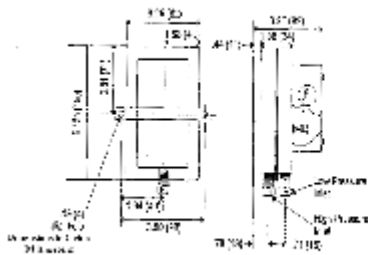

Location of Sample Lines for Typical Applications

<p>FAN OPERATION OR TRUE AIRFLOW WITH LITTLE OR NO STATIC PRESSURE.</p> <p>PROBE MUST BE PERPENDICULAR TO FLOW.</p>	<p>FAN OPERATION OR AIRFLOW WITH NO STATIC PRESSURE.</p>	<p>PROVE POSITIVE STATIC PRESSURE</p>
<p>FAN OPERATION AND TRUE AIR FLOW WITH LITTLE OR NO STATIC PRESSURE.</p> <p>PROBE MUST BE PERPENDICULAR TO FLOW.</p>	<p>SUCTION OR FAN OPERATION</p>	<p>NEGATIVE PRESSURE INCREASES AS FILTER GETS DIRTY.</p> <p>FILTER</p>



The NS2 series, Universal Small Footprint Air Switch, replaces hundreds of other small footprint exact replacement air switches today. Five separate springs cover ranges from .10"WC to 10"WC. Set screw adjustment with allen wrench included. Eight different orifice restrictors to set different time delays, and comes with two brackets for all applications.

NS2-0000-03

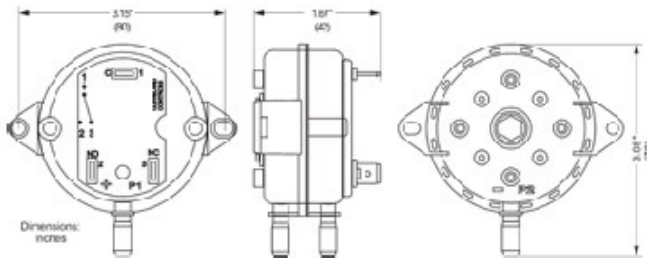
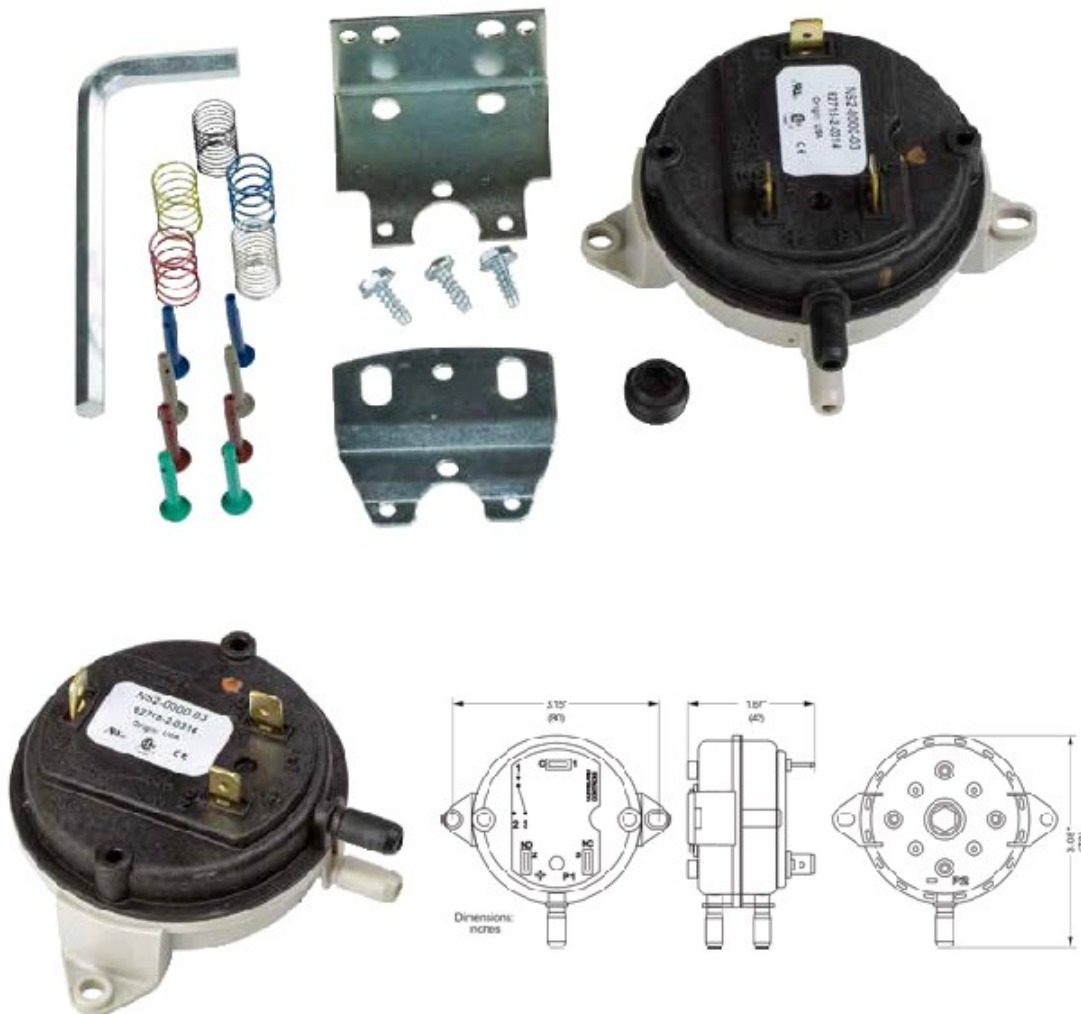

AIR SWITCHES



The EZS air switch line is the future of universal air pressure switches. Two line items allow you to replace any switch in the range of 0.15" – 10.0" W.C.

The "EZ Set" feature allows you to easily set EZS air switches without monometers, meters, or any tool other than the included allen wrench. Simply turn the dial and set it using the sight glass on the underside of the switch.

Out of the box, the switch comes in the historic RSS physical profile. If you have space limitations, or need to fit the NS2 profile area, once pressure is set, simply remove the outer case, and you have a set NS2 profile switch

EZS-495-11 (0.15" – 2.0")

EZS-498-13 (2.0"-10.0")



Visible Setpoint Dial

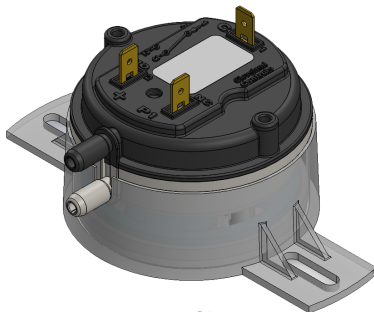

Fits Historic RSS Profile



Fits Historic NS2 Profile

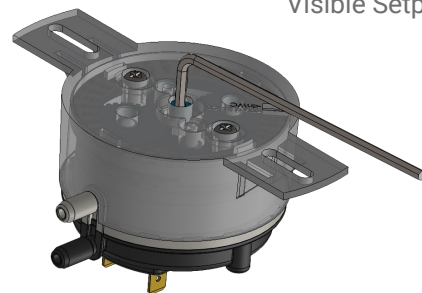

EZ Set with Allen Wrench

Part Number	EZS Series		RSS Series		NS2 Series
	EZS-495-11	EZS-498-13	RSS-495-11	RSS-498-13	NS2-0000-03
Setpoint Range (in. W.C.)	0.15" to 2.0"	2.0" to 10.0"	0.15" to 1.0"	1.0" to 4.0"	0.10" to 10.0"
Positive, Negative Differential Pressure	✓	✓	✓	✓	✓
UL, CUL, CSA, CE, AGA Approval	✓	✓	✓	✓	✓
-40 F to 190 F Temperature Range	✓	✓	✓	✓	✓
SPDT contacts rated for 100,000 cycles min.	✓	✓	✓	✓	✓
Contains Orifices for Time Delay Applications	✓	✓			✓
No Need to Select and Insert Spring	✓	✓	✓	✓	
'EZ' Set - No Tools Required	✓	✓			
Fits Both RSS and NS2 Physical Profile	✓	✓			
Future Availability	✓	✓			✓



**CLEVELAND
CONTROLS™**

**CLEVELAND CONTROLS AIR PRESSURE SENSING
SWITCH KIT**



Series RSS Air Sensing Switch Kit contains compact, economical switches designed for a residential furnace and light commercial aftermarket applications. The RSS-495 switches have an adjustable set point range of 0.25" W.C. to 1.0" W.C. The RSS-498 switches have an adjustable set point range of 1.0" W.C. to 4.0" W.C. The field adjustability makes these switches ideal for aftermarket residential furnace applications, electronic air cleaners and humidifiers.

RSS-495-11

RSS-498-13



Square Air Switch Tubing – Silicone

Square outside prevents kinking. Easily change out corroded tubing. 5' of tubing comes in each bag. Silicone material is easy to cut to size in the field and resistant to high temperatures.

SQAST-SIL-5



Square Air Switch Tubing – Neoprene

Square outside prevents kinking. Easily change out corroded tubing. 5' of tubing comes in each bag. Neoprene material is easy to cut to size in the field

SQAST-5

CUSHIONED TUBING CLAMPS, GALVANIZED

These channel mounted clamping systems are ideal for multiple line runs. They absorb shock and vibration, reduce unwanted noise, and prevent galvanic corrosion. The clamp features a unique shoulder stud which is securely fastened to one clamp half. This Controlled Squeeze design eliminates over-tightening and rotation while nylon insert nut assures a positive lock. Stocked with electro-dichromate finish, and available in stainless steel. The cushion is chemical resistant, and has a -50°F to 275°F operating range. A patented "Living Hinge" allows the cushion to be spread apart for quick, easy installation.

Z004T008 thru Z066N074

TUBE X PIPE O.D.



Z004T008	1/4"
Z006T010	3/8"
Z008T012	1/2"
Z010T014	5/8"
Z012T016	3/4"
Z014T018	7/8"
Z016T020	1"
Z018T022	1-1/8"
Z020T024	1-1/4"
Z022T026	1-3/8"
Z024N028	1-1/2"
Z026N030	1-5/8"
Z028N032	1-3/4"
Z030N034	1-7/8"
Z032N036	2"
Z034N040	2-1/8"
Z036N042	2-1/4"
Z038N044	2-3/8"
Z040N046	2-1/2"
Z042N048	2-5/8"
Z046N052	2-7/8"
Z050N054	3"
Z050N056	3-1/8"
Z053N060	3-5/16"
Z056N062	3-1/2"
Z058N064	3-5/8"
Z064N072	4"
Z066N074	4-1/8"

Stainless Steel Vibration Absorbers



Specify ESP Vibration Absorbers in refrigeration and air conditioning systems to:

- Reduce vibration and noise
- Extend compressor life
- Allow for horizontal or vertical movement
- Relieve stress on the compressor housing
- Reduce wear on the bearings

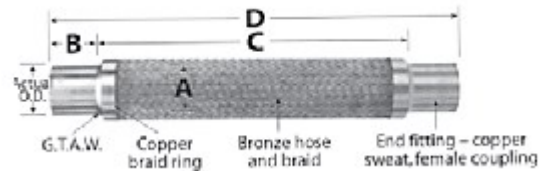

Stainless Steel Vibration Absorbers Specifications

Part Number	To Fit Copper Tube		"A" Nominal Hose I.D.	"B" Fitting Length	"D" Assembly Length	Maximum Working Pressure PSIG@70° F
	Actual O.D.	Nominal Tube				
VAB-2	1/4"	1/8"	1/4"	1/2"	7"	450
VAB-3	3/8"	1/4"	1/4"	1/2"	8-1/4"	450
VAB-4	1/2"	3/8"	3/8"	5/8"	9"	450
VAB-5	5/8"	1/2"	1/2"	7/8"	9-3/4"	450
VAB-6	3/4"	5/8"	1/2"	1"	10"	450
VAB-7	3/4"	5/8"	3/4"	1-1/8"	11-1/4"	440
VAB-8	7/8"	3/4"	3/4"	1-1/4"	11-1/2"	440
VAB-9	1-1/8"	1"	1"	1-1/2"	13"	400
VAB-10	1-3/8"	1-1/4"	1-1/4"	1-5/8"	14-3/4"	400
VAB-11	1-5/8"	1-1/2"	1-1/2"	2"	17"	400
VAB-12	2-1/8"	2"	2"	2-1/2"	20"	390
VAB-13SS	2-5/8"	2-1/2"	2-1/2"	3"	24"	340
VAB-14SS	3-1/8"	3"	3"	3-1/2"	27"	300

1. Minimum burst pressure is 5 times the maximum working pressure.
2. Hose may be helical or annular type.
3. Hose = C51000 (95/5)
Braid = C22000 (90/10)
 1. Length = D+1/4"
 2. Hose is not to be used with ammonia refrigerants

CHILLER BUILDER KIT

Chiller Builder Kits For Brazed Plate Evaporators

Contact ESP for part number information and pricing regarding chiller builder kits

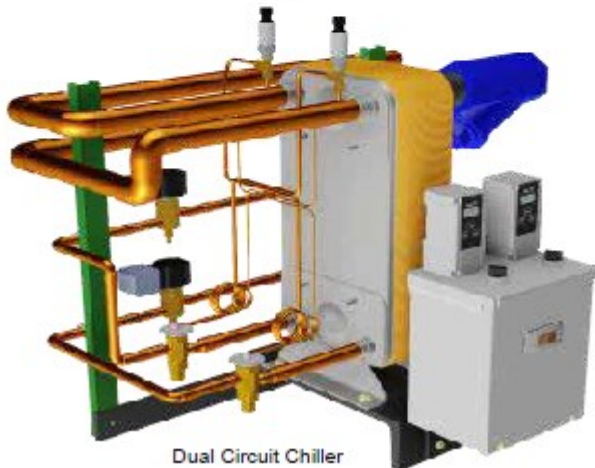
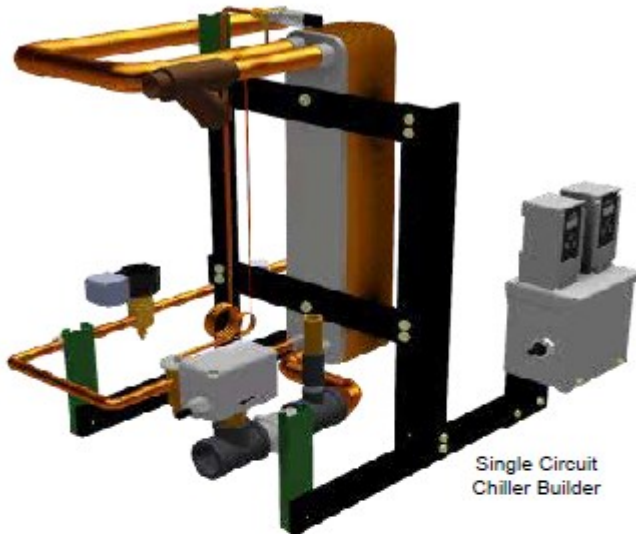

Combine a Chiller Builder Kit, BHE evaporator, and your condensing unit to create a complete water chiller ready to be piped to your cooling load.

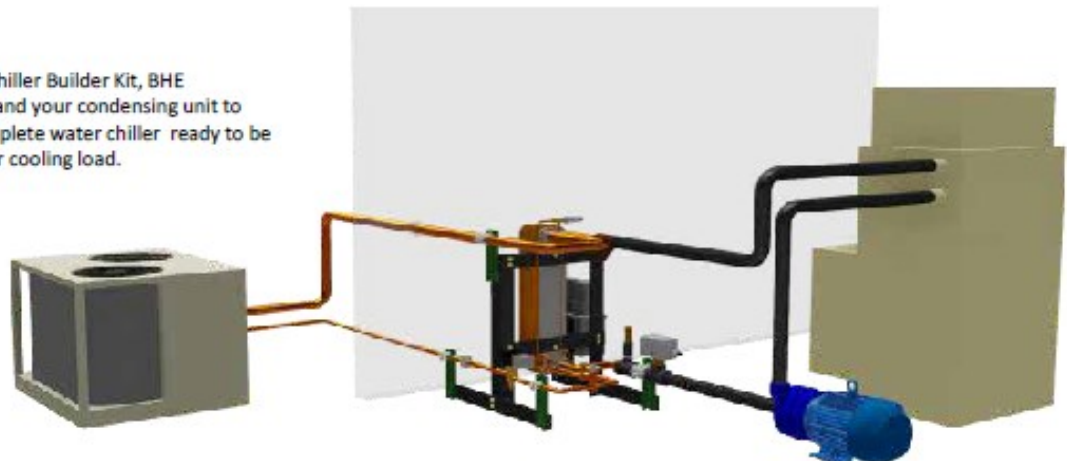

BUILD A COMPLETE WATER CHILLER QUICKLY AND ECONOMICALLY

CONNECTS TO YOUR CONDENSING UNIT

IMMEDIATE AVAILABILITY

Combine a Chiller Builder Kit with an Alfa Laval Brazed Plate Evaporator for a complete Low Side Chiller ready to be connected to your condensing unit. The Chiller Builder components and controls are properly matched to the evaporator, and can be used in either pump down and non-pump-down systems.

The evaporator and components are quickly assembled on the compact structural steel frame. The completed assembly can be conveniently located near the air handler or process load.

The Chiller Builder controls connect to the condensing unit thermostat terminals for simple and fool-proof installation and operation.

- Uses compact and efficient Brazed Plate Evaporators
- Available in single and dual refrigerant circuit models
- Available for R410A, R404A, R507, R22
- Brand name components
- Available in ranges from 2 to 80 tons
- Entire kit can be assembled in less than one hour
- Includes Digital Controls

Included Components

Structural Steel Framework | Electronic chiller controller with fault indicating lights | Temperature control | Electronic low pressure freeze protection switch | Expansion valve | Solenoids | Sight glass | Freezestat | Flow switch | Water strainer

CHILLER BUILDER KIT

Contact ESP for part number information and pricing regarding chiller builder kits

Chiller builder kits provide a simple solution for system installers. The systems include all of the components needed for the low side package and can be assembled in less than one hour.

TXKIT Single Circuit Standard Designs TXKIT are available in standard designs for water duty. They are available in 6 catalog models, which can be used with chiller barrels from 2 to 40 tons. The evaporator barrel is not included. All kits utilize brand name components.

TXKIT/DTXKIT Multiple Circuit Standard Designs

TXKIT/DTXKIT are available in standard designs for water duty. They are available in 9 catalog models, which can be used with evaporator barrels from 10 to 75 tons. The chiller barrel is not included. All kits utilize brand name components.

Included Components

- Control Power Supplies
- Expansion Valve
- Flow Switch
- Framework
- Freezestat
- Low Pressure Switch
- Piping
- Solenoids
- Temperature Controls

Non-Approved Refrigerants Unless Cleared by the Factory Ammonia/R717, due to copper tubing. R404A, R410A & R507A due to recommended operating pressures, custom units are available for these refrigerants.

Other Refrigerants

All other refrigerants must be approved by Standard Refrigeration/Alfa Laval before use.

Alternative Options

Kits with a supplied chiller barrel, use CBKIT. For a clean water alternative, use a BHE-KIT (brazed evaporator builder kit).

Approved Refrigerants R22, R134a.



PART NUMBER INDEX

00402	68
00403	68
00405	68
00406	68
00408	68
00415	68
00442	68
00450	68
722	15
729	15
02026	72
6952	36
6953	36
6954	36
6955	36
6956	36
10001	71
10002	71
10003	71
10007	71
10209	66
10210	66
10211	66
10212	66
10213	66
10214	66
10216	66
10217	66
10218	66
10220	66
10221	66
10222	66
10223	66
10224	66
10225	66
10226	66
13000	79
13001	79
13002	79
13003	79
13006	79
13008	79
13010	79
13041	79
13042	79

13044	79
14402	67
14404	67
14406	67
14408	67
14410	67
14412	67
14414	67
14416	67
14418	67
14442	67
14444	67
14446	67
14448	67
14450	67
14452	67
14454	67
14456	67
14458	67
14465	78
14466	78
14467	78
14468	78
14476	78
14477	78
14504	66
14506	66
14509	66
14510	66
14512	66
14515	66
14517	66
14518	66
14520	66
14524	66
14529	66
14530	66
14533	66
14539	66
14547	66
14565	66
14567	66
14573	66
14582	66
14588	66

24800	72
25010	73
25013	73
25015	73
25301	74
25302	74
25404	74
25405	74
25406	74
25407	74
27668	75
27698	75
30200	12
30328	76
30438	76
30548	76
30599	76
30600	76
30658	76
30660	76
30664	76
30666	76
31438	76
31448	76
31458	76
33066	75
33076	75
33086	75
33096	75
33106	75
33116	75
33126	75
33266	75
33277	75
33288	75
33299	75
33310	75
33311	75
33312	75
33314	75
36048	76
36072	76
40437	15
41218	78
41228	78

PART NUMBER INDEX

41238	78
41248	78
43206	77
43208	77
43212	77
43214	77
43216	77
43218	77
43222	77
43224	77
43226	77
43228	77
43232	77
43234	77
43236	77
43238	77
43306	77
43308	77
43312	77
43314	77
43316	77
43318	77
43322	77
43324	77
43326	77
43328	77
43332	77
43334	77
43336	77
43338	77
43536	77
43539	77
43542	77
43545	77
43548	77
43551	77
43553	77
43556	77
43559	77
43562	77
43565	77
43568	77
43571	77
43573	77
43576	77

43579	77
43636	67
43639	67
43642	67
43645	67
43648	67
43651	67
43653	67
43656	67
43658	67
43660	67
43662	67
43664	67
43736	67
43739	67
43742	67
43745	67
43748	67
43751	67
43753	67
43756	67
43758	67
43760	67
43762	67
43764	67
46302	78
46304	78
46328	78
46348	78
55104	74
55105	74
62034	72
65341	74
66517	37
66518	37
66519	37
66520	37
66551	37
66552	37
66553	37
66554	37
66587	37
66588	37
66590	37
67118	72

67191	71
67192	71
67193	71
67194	71
67195	71
67196	71
67197	71
67230	71
67231	71
67232	71
67233	71
67234	71
67235	71
67240	73
67241	73
67242	73
67243	73
67244	73
67245	73
76026	69
76200	68
76210	68
76220	68
76221	69
76243	68
76252	78
76253	78
76254	78
76255	78
76256	78
76257	78
76258	78
76324	69
76524	69
81002	75
81003	75
81005	75
81006	75
81008	74
81009	74
81010	74
81018	74
81020	74
81025	74
81044	74

PART NUMBER INDEX

81045	74
81232	73
81233	73
81234	73
81616	72
81617	72
93490	79
93491	79
93492	79
121071	4
384110	35
429762	35
666589	37
3838506	35
3838508	35
3838509	35
3843043	35
00925-1	65
00926-1	65
00927-1	65
00928-1	65
00929-1	65
00930-1	65
00931-1	65
00932-1	65
00933-1	65
00934-1	65
00935-1	65
00936-1	65
00937-1	65
00943-1	65
00944-1	65
00945-1	65
00947-1	65
00948-1	65
00949-1	65
00950-1	65
00951-1	65
00952-1	65
00953-1	65
00954-1	65
00963-6	66
00964-6	66
00965-6	66
00966-6	66

00967-6	66
00968-6	66
00969-6	66
00996-12	66
00998-100	66
00998-12	66
012-DC	12
07-012 / 08-012	23
07-034 / 08-034	23
07-100 / 08-100	23
10-212	12
10-219	12
10T	57
132ME	15
15-012 / 16-012	22
15-014	22
15-034 / 16-034	22
15-038	22
15-100 / 16-100	22
15-114 / 16-114	22
1A	43
2006-34	63
2006-38	63
2007-31	63
2007-33	63
2007-41	63
2007-44	63
2026-14	63
20T	57
20T1	57
221-2401	52
221-2401/K000-0004	52
221-412	52
221-412/996-010	52
221-413	52
221-413/996-010	52
221-415	52
221-415/996-010	52
263-R	49
2B	43
30T	57
30T1	57
3C	43
40T	57
40T1	57

40T2	57
43482/93482	79
43484/93484	79
43486/93486	79
43502/93502	70
43503/93503	70
43504/93504	70
43507/93507	70
43510/93510	70
43513/93513	70
43516/93516	70
43519/93519	70
43522/93522	70
43525/93525	70
43531/93531	70
43533/93533	70
43602/93602	70
43603/93603	70
43604/93604	70
43607/93607	70
43610/93610	70
43613/93613	70
43616/93616	70
43619/93619	70
43622/93622	70
43625/93625	70
43628/93528	70
43628/93628	70
43631/93631	70
43633/93633	70
43702/93702	69
43703/93703	69
43704/93704	69
43707/93707	69
43710/93710	69
43713/93713	69
43716/93716	69
43719/93719	69
43722/93722	69
43725/93725	69
43728/93728	69
43731/93731	69
43733/93733	69
50T	57
522-0024-24	64

PART NUMBER INDEX

522-0024-36	64
533-0024-24	64
533-0024-36	64
58-012/ 59-012	23
58-014 / 59-014	23
58-034 / 59-034	23
58-038 / 59-038	23
58-100 / 59-100	23
58-114 / 59-114	23
60-012	22
60-034	22
60T	57
60T4	57
6773-02	36
6773-03	36
6773-04	36
6773-05	36
6884-06	36
6884-40	36
7757WC	3
810-C	50
8732A	1
8732A3	1
8732B	1
8732B3	1
8732C	1
8732C3	1
8732W	1
8732W3	1
8736R	1
90T	57
A0120D100	31
A0340D114	31
A0580D100	31
A0780D114	31
A0780D114M	32
A10WPR	42
A1180D114	31
A1180D134	31
A1180D134M	32
A12WPR	42
A1380D134	31
A35WPR	42
AA0120D100	32
AA0380D100	32

AA0580D100	32
AA0780D114	32
AA1180D114	32
AA1380D134	32
AB10	56
ABC10-R	49
ABC12-R	49
ABC15-R	49
ABC1-R	49
ABC20-R	49
ABC2-R	49
ABC30-R	49
ABC3-R	49
ABC4-R	49
ABC5-R	49
ABC6-R	49
ABC8-R	49
ABSP25	4
AC&RA	1
AC&RB	1
AC&RC	1
AC&RW	1
AFS-222-121	80
AFS-262-121	80
AGC1/2-R	49
AGC1/4-R	49
AGC1/8-R	49
AGC10-R	49
AGC1-1/2-R	49
AGC12-R	49
AGC15-R	49
AGC1-6/10-R	49
AGC1-R	49
AGC20-R	49
AGC2-1/2-R	49
AGC25-R	49
AGC2-R	49
AGC3/4-R	49
AGC3/8-R	49
AGC30-R	49
AGC3-R	49
AGC4-R	49
AGC5-R	49
AGC6-R	49
AGC8-R	49

AGX1	49
AGX1/4	49
AGX2	49
AGX2-1/2	49
AGX3	49
AGX3/8	49
AGX4	49
AGX5	49
ALDP	45
AP12	8
AP14	8
ATC1	51
ATC10	51
ATC15	51
ATC2	51
ATC20	51
ATC25	51
ATC3	51
ATC30	51
ATC4	51
ATC40	51
ATC5	51
ATC7-1/2	51
ATM3	53
ATM5	53
AW12	13
AW58	13
BH1	16
BRT10	18
BS30	56
BUCKET-5GR	40
BUCKETLID	40
BUCKETSEAT	40
BURCKET-5GW	40
BX50	60
BY12	19
BY34	19
CC100	9
CC12	9
CGR10	17
C-1K55-A020	19
CO2-100	25
CO2-12	25
CO2-12T	25
CO2-20-100	25

PART NUMBER INDEX

CO2-20-12	25
CR32	59
CTB25	38
CV-2 DVS	61
CV-3 DVS	61
DLG-1	25
DLG-2	25
DVS-2	61
DVS-3	61
DVS-4	61
EATC3-25	53
EATC5-25	53
EC-200	48
EL10	11
EP2	3
EZS-495-11	82
EZS-498-13	82
FA6060	44
FB100	13
FF75	10
FG12	48
FLEXB-6	24
FLEXCON1	24
FLEXCON125	24
FLEXCON125150	24
FLEXCON150	24
FLEXCON2	24
FLEXCON23	24
FLEXCON3	24
FLEXCON34-6	24
FLEXCON-BULK	24
FM222	3
FP2	51
FP3	51
FRNR10	50
FRNR100	50
FRNR12	50
FRNR125	50
FRNR15	50
FRNR150	50
FRNR175	50
FRNR2	50
FRNR20	50
FRNR200	50
FRNR2-1/2	50

FRNR225	50
FRNR25	50
FRNR30	50
FRNR35	50
FRNR4	50
FRNR40	50
FRNR45	50
FRNR5	50
FRNR50	50
FRNR5-6/10-	50
FRNR60	50
FRNR6-1/4	50
FRNR70	50
FRNR8	50
FRNR80	50
FRNR90	50
FRSR10	50
FRSR100	50
FRSR12	50
FRSR15	50
FRSR175	50
FRSR2	50
FRSR20	50
FRSR25	50
FRSR30	50
FRSR3-2/10	50
FRSR35	50
FRSR40	50
FRSR45	50
FRSR5	50
FRSR50	50
FRSR60	50
FRSR70	50
FRSR8	50
FRSR80	50
FRSR9	50
FRSR90	50
FS1000	47
FS3000	47
FS5000	47
FS7000	47
FS9000	47
FSCM00	47
FW1701	15
G325A	7

GB10	33
GS516	13
H012FL034D	27,28
H012FL034T	27,28
H012FL100D	27,28
H012FL100T	27,28
H012OD100D	27,28
H012OD100T	27,28
H034OD114D	27,28
H034OD114T	27,28
H038FL034T	27,28
H038FL100D	27,28
H038OD034T	27,28
H038OD100D	27,28
H058FL100D	27,28
H058FL100T	27,28
H058OD100D	27,28
H058OD100T	27,28
H058OD114D	27,28
H078OD114D	27,28
H078OD114T	27,28
H078OD134D	27,28
H118OD114T	27,28
H118OD134T	27,28
H118OD14D	27,28
H118OD14D	27,28
H138OD134T	27,28
H138OD14D	27,28
HB34	48
HC12-100	55
HC12-25	55
HC12-50	55
HC14-100	55
HC14-25	55
HC14-50	55
HD32	58
HG-501A	48
HP215	19
HP510-115	19
HPCH	63
HPCH18	63
HPCH24	63
HPCH30	63
HPCH36	63
HPCH48	63

HPHK	63
HRK	51
HVACSC-1	62
HVN1	59
IS005	59
KTKR1	49
KTKR10	49
KTKR15	49
KTKR20	49
KTKR25	49
KTKR3	49
KTKR30	49
KTKR3-1/2	49
KTKR4	49
KTKR5	49
KTKR6	49
LD10	20
LDF357N-MPT	19
LDF359N-MPT	19
LW601	14
MDL10-R	49
MDL1-2/10-R	49
MDL15-R	49
MDL1-R	49
MDL20-R	49
MDL2-R	49
MDL30-R	49
MDL3-R	49
MDL4-R	49
MDL5-R	49
MDL6-R	49
MDL7-R	49
MDL8-R	49
MW10	16
NS2-0000-03	81
NT02	10
P30002	5
P30002	5
P30033	5
P30181	5
PB12-100	55
PB12-25	55
PB12-50	55
PB14-100	55
PB14-25	55

PB14-50	55
PB16	6
PC100	8
PC12	8
PC14	8
PCL DISPLAY	21
PCL12	21
PCL14	21
PCL38	21
PCL58	21
PD12-2	55
PE44	17
PG100	8
PG14	8
PH10	18
POP10	11
POP15	11
POP20	11
POP3	11
POP3Z	11
POP5	11
POP5Z	11
PP100	8
PP12	8
PP14	8
PUP63	7
PY38	19
QB1	20
QBA	20
RAD2	72
RC034-2	32
RC100-2	32
RC114-2	32
RC134-1	32
RH-10	18
RHB-82	46
RHB-82G	46
RS10	14
RS100	55
RS15	14
RS21	14
RS31	14
RS60	55
RS75	55
RSS-495-11	83

RSS-498-13	83
S10	50
S15	50
S2	50
S20	50
S210	50
S25	50
S3	50
S30	50
S3-1/2	50
S3-2/10	50
S4	50
S5	50
S6-1/4	50
S8	50
SB30	39
SB72	39
SC1	50
SC10	50
SC15	50
SC2	50
SC20	50
SC25	50
SC3	50
SC30	50
SC35	50
SC4	50
SC40	50
SC45	50
SC5	50
SC50	50
SC6	50
SC60	50
SDT-25S	44
SE004	43
SE008	43
SE150	43
SE45	44
SGRT	18
SH12KIT	64
SH12Y	64
SH18KIT	64
SH18Y	64
SL20	50
SL25	50

SL30	50
SQAST-5	83
SQAST-SIL-5	83
SSU	51
SSY	51
ST1236-31	45
T10	50
T1-1/4	50
T12	50
T15	50
T1-6/10	50
T2	50
T2-/12	50
T20	50
T25	50
T30	50
T3-1/2	50
T3-2/10	50
T4	50
T4-1/2	50
T5	50
T6-1/4	50
T8	50
TECK50	61
TG007	57
TGII	57
TL15	50
TL20	50
TL25	50
TL30	50
TLFL	54
TP01CL	61
TP02CL	61
TP03CL	61
TP04CL	61
TP06M	61
TP07M	61
TP08M	61
TP35	47
TP50	47
TR034-6	33
TR100-6	33
TR10-12	33
TR114-6	33
TR134-6	33

TS32	58
TT10	54
TT260	9
TT520	9
TTUL260	9
TTUL520	9
UD12	44
UHS120	41
UHS24	41
UHS99	41
V0120D100D	29
V0120D100T	29
V0380D034D	29
V0580D100D	29
V0580D100T	29
V0780D114D	29
V0780D114T	29
V1180D114D	29
V1180D114T	29
V1380D134T	29
VAB-10	85
VAB-11	85
VAB-12	85
VAB-13SS	85
VAB-14SS	85
VAB-2	85
VAB-3	85
VAB-4	85
VAB-5	85
VAB-6	85
VAB-8	85
VAB-9	85
VM116B	2
VM116G	2
VM116W	2
VP24	10
VR-554	35
WC05	38
WC10	38
WDRC 10 3	6
WDRC GAL	6
WF310	5
WM1	16
XHP222	3
XT150	2

XT250	2
Z004T008	84
Z006t010	84
Z008T012	84
Z010T014	84
Z012T016	84
Z014T018	84
Z016T020	84
Z018T022	84
Z020T024	84
Z022T026	84
Z024N028	84
Z026N030	84
Z028N032	84
Z030N034	84
Z032N036	84
Z034N040	84
Z036N042	84
Z038N044	84
Z040N046	84
Z042N048	84
Z046N052	84
Z050N056	84
Z053N060	84
Z056N062	84
Z058N064	84
Z064N072	84
Z066N074	84
ZT10	17

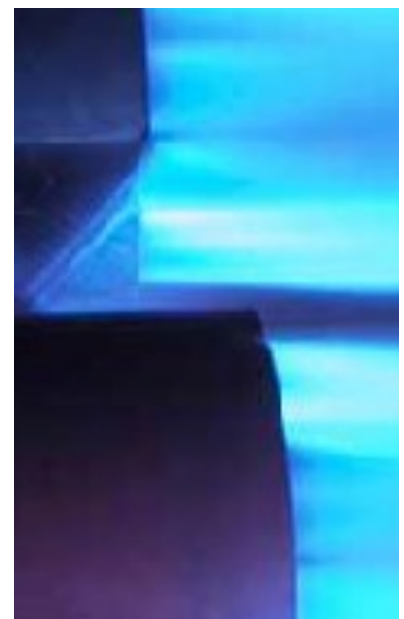

PO Box 391
Vandalia, OH 45377
(937) 898-0391
www.espcompany.com

